



TENDER DOCUMENT

**PROPOSED SUPPLY, INSTALLATION, TESTING
AND COMMISSIONING OF MEDICAL OXYGEN
PIPING INFRASTRUCTURE AND RELATED
MANIFOLD HOUSING CONSTRUCTION WORKS IN
VARIOUS FAITH BASED ORGANISATION (FBO)
HEALTH FACILITIES IN KENYA**

AMREF HEALTH AFRICA IN KENYA

TENDER NO.: AMREF/27/08/2024/017

LOT NUMBER ONE (1)

(RIFT VALLEY REGION)

INTRODUCTION

Amref Health Africa hereinafter referred to as the Client, Employer and Project Manager intends to invite contractors to tender for the proposed supply, installation, testing and commissioning of medical oxygen infrastructure and related manifold housing construction works to support FBO health facilities across various counties.

Proposed supply and installation of the medical oxygen infrastructure will comprise the following;

- (a) Oxygen piping installation, testing and commissioning works
- (b) Oxygen manifold installation, testing and commissioning works
- and
- (c) Oxygen manifold housing construction works

SIGNATURE AND SPECIAL NOTES

Supplied as part of the contract for;

Proposed supply, installation, testing and commissioning of medical oxygen piping infrastructure and related manifold housing construction works to support FBO health facilities across various counties.

PREPARED & ISSUED BY:

Amref Health Africa
P.O Box 30125 - 00100
Nairobi

The contract for the above-mentioned works entered into on the day of 20 by the undersigned parties, refers to these Bills of Quantities consisting and the Ministry of Works general specification dated 1976, (together with any amendments thereto issued since the date of publication) which shall be read and construed as part of the said contract.

.....
CONTRACTOR

.....
CLIENT
AMREF HEALTH AFRICA

Date:

Date:

SPECIAL NOTES

The contractor is required to check the pages of these Bills of Quantities together with all collections and summaries and should he find any missing or should the contractor be in doubt of the precise meaning of any items of figures, for any reason whatsoever, he must inform the PROJECT MANAGER in order that the correct meaning may be decided before the date for submission of Tenders.

No liability will be admitted or claim allowed in respect of errors in the contractor’s tender due to mistakes in the Bills of Quantities which should have been rectified in the manner described above.

The Bills of Quantities and General Specifications shall be read and construed together and wherever descriptions in the Bills of Quantities do not agree with descriptions in the General Specifications, then the Bills of Quantities shall override.

In the event of any discrepancies arising between the Bills of Quantities and actual works the site measurements shall generally take precedence. However, such discrepancies between any contract documents shall immediately be referred to the PROJECT MANAGER in accordance with Clause 22 of the conditions of Contract. The discrepancies shall then be treated as a variation and be dealt with in accordance with Clause 22 of the said Conditions.

TABLE OF CONTENTS

PART A: TECHNICAL REQUIREMENTS	1
SECTION I: Invitation to Tender	1
SECTION II: Instructions to Tenderers	3
SECTION III: Tender Evaluation Criteria	12
STAGE 1: Preliminary Evaluation	12
STAGE 2: Technical Evaluation	13
STAGE 3 - Financial Evaluation	16
(a) Determination of Arithmetic Errors	16
(b) Comparison of rates	16
(c) Consistency of the Rates	16
STAGE 4 – Due Diligence	16
SECTION IV: Conditions of Contract	17
SECTION V: Appendix to Conditions of Contract	34
SECTION VI: Standard Forms	36
Form of Agreement	40
Form of Tender Security	42
Qualification Information	44
Confidential Business Questionnaire	46
Part 1 - General	46
Part 2 (a) – Individuals	46
Part 2 (b) – Partnership	46
Part 2 (c) – Registered Company	46
Part 2 (d) – Interest in the Firm	47
Details of Sub-Contractors	47
.....	48
Declaration	48
PART B: FINANCIAL	58

PART A: TECHNICAL REQUIREMENTS

SECTION I: Invitation to Tender

- Amref Health Africa invites sealed bids from eligible candidates for the tender for proposed supply, installation, testing and commissioning of medical oxygen piping infrastructure and related manifold housing construction works for various FBO health facilities in Kenya in lots as listed below;

Lot	Description	Number of Health Facilities	Name of Health Facility	County
1	Supply, Installation, Testing and commissioning of medical oxygen infrastructure and related manifold housing construction works for various FBO health facilities in Rift Valley Region as per specifications.	10	AIC Kalokol	Turkana
			Our Lady of Mercy Mission Hospital	Nakuru
			RCEA Plateau Uasin Gishu	Uasin Gishu
			Mother Francisca Mision Hospital	Nandi
			St. John's Mission Hospital Sirende	Trans-Nzoia
			Mercy Mission Hospital	Baringo
			Chesta dispensary	West Pokot
			Chesongoch Mission Hospital	Elgeyo-Marakwet
			St. Joseph Mission Hospital Kilgoris	Narok
			Litein AIC	Kericho
2	Supply, installation, testing and commissioning of medical oxygen infrastructure and related manifold housing construction works for various FBO health facilities in Coastal & Eastern Region as per specifications.	12	Sisters of St. Joseph Catholic Dispensary	Kwale
			Mewa Hospital	Mombasa
			Maria Teresa Nuzzo	Lamu
			Mbungoni Catholic Dispensary (CBHC)	Mombasa
			Tawfiq Muslim hospital	Kilifi
			Oasis Medical center	Kilifi
			Daba AIC dispensary	Tana River
			St. Joseph Shelter of Hope, Voi	Taita-Taveta
			Muthale Mission Hospital	Kitui
			Kikoko Mission Hospital	Makueni
			Mandera North Sub County Hospital (Rhamu)	Mandera
			Sister Maternity Homses (SIMAHO)	Garissa
3	Supply, installation, testing and commissioning of medical oxygen infrastructure and related manifold housing construction works for various FBO health facilities in Nairobi, Central & North Eastern Region as per specifications.	13	Consolata Hospital Kyeni	Embu
			Christian Community Services Dispensary	Meru
			Matercare Maternity Hospital	Isiolo
			AIC Dispensary	Isiolo
			Gatab Health Centre	Marsabit
			Pope Benedict XVI Catholic Hospital Nyahururu	Laikipia
			Beacon Of Hope Ongata Rongai	Kajiado
			ACK Mt Kenya Hospital	Kirinyaga
			Consolata Hospital Mathari	Nyeri
			Assumption of Mary Ithanga Health Center	Murang'a
			Nazareth Ruiru Hospital	Kiambu
			Kimende Orthodox Health Center and Maternity Home	Kiambu
St. Scholastica Uzima Hospital	Nairobi			
4	Supply, installation, testing	11	Gesusu SDA Dispensary	Kisii
			Itibo Adventist Mission Hospital	Nyamira

and commissioning of medical oxygen infrastructure and related manifold housing construction works for various FBO health facilities in Nyanza & Western Region as per specifications.	St Joseph Mission Hospital Migori	Migori
	St Paul's Mission Hospital	Homa Bay
	ACK Maseno	Kisumu
	Awasi Catholic Mission Dispensary	Kisumu
	Dolphin Nursing Home	Siaya
	Namasoli Health Center	Kakamega
	Itando Mission Hospital	Vihiga
	Namboboto ACK	Busia
	ICFEM Dreamland	Bungoma

2. This tender document is only for **Lot Number One (1)**.
3. Interested eligible bidders may obtain further information from the **Amref Health Africa website www.amref.org**
4. Complete sets of tender documents can be downloaded from Amref Health Africa website; <http://amref.org/ways-to-give/tenders/> by interested bidders upon payment of non-refundable fee of **Ksh 1000 PER LOT**. The payment should be made through the following Bank account(s): **Kenya Commercial Bank, Kipande House Branch, Account No: 1111429243 OR National Bank of Kenya, Wilson Branch, Account No: 01020058235400 OR Pay bill: 890750 Account No: (Indicate the Tender Name)**.
5. Candidates will then attach the original banking/deposit slip to the tender documents as proof of purchase. Candidates interested in buying more than one lot **Must** pay for each lot separately and attach the original banking/deposit slips respectively to the tender document.
6. Completed tender documents for preliminary, technical requirements and filled BOQ are to be enclosed in a plain envelope marked with the tender reference number and tender name. **Please note that only one complete tender document per lot is required (Do not provide additional copies per lot)**.
7. Tenders must be delivered to the address below not later than **Tuesday 10th September, 2024 at 12.00 noon** and must be accompanied by a tender security of **Kshs 1,000,000.00** in the Currency specified in the tender document in the form of a bank guarantee from a reputable bank and must be delivered with the Tender Documents in the technical bid, **(bid bonds from insurance companies will NOT be accepted)**.
8. Tenders should be dropped at the Amref Health Africa - KCO Big Tender Box at the Main Reception. Tenders will be opened at 12 noon on the closing date in the presence of the Tenderers' representatives who choose to attend at the Amref Health Africa Large Lecture room. Electronic bidding will not be permitted. No bids will be accepted after 12 noon on the closing day.

Prices quoted should be inclusive of VAT and all other applicable taxes and must be in Kenya Shillings and shall remain valid for 90 days from the closing date of the tender.

NOTE: Global Fund grants are tax exempt. Bidders will be required to submit quotations inclusive of 16% VAT. Payment(s) to the successful bidder(s) shall be made in total exclusive of VAT and

tax exemption certificate will be issued accordingly. Successful applicants shall be required to submit proforma invoice and valid tax compliance certificate upon receipt of LPO for processing of specific VAT exemption certificate.

Amref Health Africa reserves the right to accept or reject any or all bids and is not bound to give reasons for its decision.

Specific Instructions

- 8.1 Bidders must quote for all items and quantities as indicated per Lot in order to qualify for evaluation. The tenderers shall submit priced BoQ for cylinder rack and manifold shed for each facility in the LOT.
- 8.2 The document MUST be clearly arranged with separators and tape or spiral bound at the time of submission. (Bid documents not properly bound will NOT be accepted)
- 8.3 The final bound tender document must be serially paginated (All pages in the document from top page (immediately after top cover) to the last page (one before back cover) including table of content, separators, brochures, bank deposit slip and any other attachments) in a continuous ascending order from the first page to the last in this format; 1,2,3.....n where n is the last page.
- 8.4 Bids will be evaluated on Lot by Lot basis.

SECTION II: Instructions to Tenderers

1. General/Eligibility/Qualifications/Joint venture/Cost of tendering.
 - 1.1 The Employer as defined in the Appendix to Conditions of Contract invites tenders for Works Contract as described in the tender documents. The successful tenderer will be expected to complete the Works by the Intended Completion Date specified in the tender documents.
 - 1.2 All tenderers shall provide the Qualification Information, a statement that the tenderer (including all members of a joint venture and subcontractors) is not associated, or has not been associated in the past, directly or indirectly, with the Consultant or any other entity that has prepared the design, specifications, and other documents for the project or being proposed as Project Manager for the Contract. A firm that has been engaged by the Employer to provide consulting services for the preparation or supervision of the Works, and any of its affiliates, shall not be eligible to tender.
 - 1.3 All tenderers shall provide in the Form of Tender and Qualification Information, a preliminary description of the proposed work method and schedule as necessary.
 - 1.4 In the event that pre-qualification of potential tenderers has been undertaken, only tenders from pre-qualified tenderers will be considered for award of Contract. These qualified tenderers should submit with their tenders any information updating their original pre-qualification applications or, alternatively, confirm in their tenders that the originally submitted pre-qualification information remains essentially correct as of the date of tender submission.
 - 1.5 Where no pre-qualification of potential tenderers has been done, all tenderers shall include the following information and documents with their tenders, unless otherwise stated:
 - a) copies of original documents defining the constitution or legal status, place of registration, and principal place of business; written power of attorney of the signatory of the tender to commit the tenderer.
 - b) total monetary value of construction work performed for each of the last five years:
 - c) experience in works of a similar nature and size for each of the last five years, and details of work under way or contractually committed; and names and addresses of clients who may be contacted for further information on these contracts;
 - d) major items of construction equipment proposed to carry out the Contract and an undertaking that they will be available for the Contract.
 - e) qualifications and experience of key site management and technical personnel proposed for the Contract and an undertaking that they shall be available for the Contract.
 - f) reports on the financial standing of the tenderer, such as profit and loss statements and auditor's reports for the past two years;
 - g) evidence of adequacy of working capital for this Contract (access to line(s) of credit and availability of other financial resources);
 - h) authority to seek references from the tenderer's bankers;
 - i) information regarding any litigation, current or during the last five years, in which the tenderer is involved, the parties concerned and disputed amount; and

- j) proposals for subcontracting components of the Works amounting to more than 10 percent of the Contract Price.

1.6 Tenders submitted by a joint venture of two or more firms as partners shall comply with the following requirements, unless otherwise stated:

- a) the tender shall include all the information listed in clause 1.5 above for each joint venture partner;
- b) the tender shall be signed so as to be legally binding on all partners;
- c) all partners shall be jointly and severally liable for the execution of the Contract in accordance with the Contract terms;
- d) one of the partners will be nominated as being in charge, authorized to incur liabilities, and receive instructions for and on behalf of all partners of the joint venture; and
- e) the execution of the entire Contract, including payment, shall be done exclusively with the partner in charge.

1.7 To qualify for award of the Contract, tenderers shall meet the following minimum qualifying criteria;

- a) annual volume of construction work of at least 2.5 times the estimated annual cash flow for the Contract;
- b) experience as main contractor in the construction of at least two works of a nature and complexity equivalent to the Works over the last 5 years (to comply with this requirement, works cited should be at least 70 percent complete);
- c) proposals for the timely acquisition (own, lease, hire, etc.) of the essential equipment listed as required for the Works;
- d) a Contract manager with at least five years' experience in works of an equivalent nature and volume, including no less than three years as Manager; and
- e) liquid assets and/or credit facilities, net of other contractual commitments and exclusive of any advance payments which may be made under the Contract, of no less than 4 months of the payment flow under this Contract.

1.8 The figures for each of the partners of a joint venture shall be added together to determine the tenderer's compliance with the minimum qualifying criteria of clause 1.7 (a) and (e); however, for a joint venture to qualify, each of its partners must meet at least 25 percent of minimum criteria 1.7 (a), (b) and (e) for an individual tenderer, and the partner in charge at least 40 percent of those minimum criteria. Failure to comply with this requirement will result in rejection of the joint venture's tender. Subcontractors' experience and resources will not be taken into account in determining the tenderer's compliance with the qualifying criteria, unless otherwise stated.

1.9 Each tenderer shall submit only one tender, either individually or as a partner in a joint venture. A tenderer who submits or participates in more than one tender (other than as a subcontractor or in cases of alternatives that have been permitted or requested) will cause all the proposals with the tenderer's participation to be disqualified.

- 1.10 The tenderer shall bear all costs associated with the preparation and submission of his tender, and the Employer will in no case be responsible or liable for those costs.
- 1.11 The tenderer, at the tenderer's own responsibility and risk, is encouraged to visit and examine the Site of the Works and its surroundings, and obtain all information that may be necessary for preparing the tender and entering into a contract for construction of the Works. The costs of visiting the Site shall be at the tenderer's own expense.
- 1.12 The procuring entity's employees, committee members, board members and their relative (spouse and children) are not eligible to participate in the tender.
- 1.13 Tenderers who have been blacklisted or whose contracts with the procuring entity have been terminated for non-performance in the last 2 years prior to the date of the tender advertisement are not eligible to participate in the tender.
- 1.14 The price to be charged for the tender document shall be **Kshs. 1,000.00/= Per Lot.**
- 1.15 The procuring entity shall allow the tenderer to review the tender document free of charge before purchase through the website.

2. Tender Documents

- 2.1 The complete set of tender documents comprises the documents listed below and any addenda issued in accordance with Clause 2.4.
 - a) These Instructions to Tenderers
 - b) Form of Tender and Qualification Information
 - c) Conditions of Contract
 - d) Appendix to Conditions of Contract
 - e) Specifications
 - f) Bills of Quantities
 - g) Forms of Securities
- 2.2 The tenderer shall examine all Instructions, Forms to be filled and Specifications in the tender documents. Failure to furnish all information required by the tender documents, or submission of a tender not substantially responsive to the tendering documents in every respect will be at the tenderer's risk and may result in rejection of his tender.
- 2.3 Before the deadline for submission of tenders, the Employer may modify the tendering documents by issuing an addendum. Any addendum thus issued shall be part of the tendering documents and shall be communicated in writing or email to all tenderers. Prospective tenderers shall acknowledge receipt of each addendum in writing to the Employer.
- 2.4 To give prospective tenderers reasonable time in which to take an addendum into account in preparing their tenders, the Employer shall extend, as necessary, the deadline for submission of tenders, in accordance with Clause 4.2 here below.

3. Preparation of Tenders

- 3.1 All documents relating to the tender and any correspondence shall be in English language.
- 3.2 The final bound tender document must be serially paginated (All pages in the document from top page (immediately after top cover) to the last page (one before back cover) including table of content, separators, brochures, original banking/deposit slip and any other attachments) in a

continuous ascending order from the first page to the last in this format; 1,2,3.....n where n is the last page.

3.3 The document should be clearly arranged with separators and bound.

3.4 The tender submitted by the tenderer shall comprise the following:

- (a) These Instructions to Tenderers, Form of Tender, Conditions of Contract,
- (b) Appendix to Conditions of Contract and Specifications;
- (c) Tender Security;
- (d) Priced Bill of Quantities;
- (e) Qualification Information Form and Documents;
- (f) Alternative offers where invited; and
- (g) Any other materials required to be completed and submitted by the tenderers.

3.5 The tenderer shall fill in rates and prices for all items of the Works described in the Bill of Quantities. Items for which no rate or price is entered by the tenderer will not be paid for when executed and shall be deemed covered by the other rates and prices in the Bill of Quantities. All duties, taxes, and other levies payable by the Contractor under the Contract, or for any other cause relevant to the Contract, as of 30 days prior to the deadline for submission of tenders, shall be included in the tender price submitted by the tenderer.

3.6 The rates and prices quoted by the tenderer shall only be subject to adjustment during the performance of the Contract if provided for in the Appendix to Conditions of Contract and provisions made in the Conditions of Contract.

3.7 The unit rates and prices shall be in Kenya Shillings.

3.8 Tenders shall remain valid for a period of Ninety (90) from the date of submission. However, in exceptional circumstances, the Employer may request that the tenderers extend the period of validity for a specified additional period. The request and the tenderers' responses shall be made in writing. A tenderer may refuse the request without forfeiting the Tender Security. A tenderer agreeing to the request will not be required or permitted to otherwise modify the tender, but will be required to extend the validity of Tender Security for the period of the extension, and in compliance with Clause 3.9 to 3.13 in all respects.

3.9 The tenderer shall furnish, as part of the tender, a Tender Security in the amount and form specified in the appendix to invitation to tenderers. This shall be in the amount specified in this tender document.

3.10 The format of the Tender Security should be in accordance with the form of Tender Security included in Section VI - Standard forms or any other form acceptable to the Employer. Tender Security shall be valid for 90 days beyond the validity of the tender.

3.11 Any tender not accompanied by an acceptable Tender Security shall be rejected. The Tender Security of a joint venture must define as "Tenderer" all joint venture partners and list them in the following manner: a joint venture consisting of "....."
".....", and ".....".

3.12 The Tender Securities of unsuccessful tenderers will be returned.

3.13 The Tender Security of the successful tenderer will be discharged when the tenderer has signed the Contract Agreement and furnished the required Performance Security.

- 3.14 The Tender Security may be forfeited
- (a) if the tenderer withdraws the tender after tender opening during the period of tender validity;
 - (b) if the tenderer does not accept the correction of the tender price, pursuant to Clause 5.7;
 - (c) in the case of a successful tenderer, if the tenderer fails within the specified time limit to:
 - (i) sign agreement, or
 - (ii) furnish the required Performance Security
- 3.15 Tenderers shall submit offers that comply with the requirements of the tendering documents, including the basic technical design as indicated in the Specifications. Alternatives will not be considered, unless specifically allowed in the invitation to tender. If so allowed, tenderers wishing to offer technical alternatives to the requirements of the tendering documents must also submit a tender that complies with the requirements of the tendering documents, including the basic technical design as indicated in the Specifications. In addition to submitting the basic tender, the tenderer shall provide all information necessary for a complete evaluation of the alternative, including design calculations, technical specifications, breakdown of prices, proposed construction methods and other relevant details. Only the technical alternatives, if any, of the lowest evaluated tender conforming to the basic technical requirements shall be considered.
- 3.16 The tenderer shall only submit one completed tender document per lot as described in Clause 3.4 of these Instructions to Tenderers, and containing the Form of Tender, and **clearly marked with the tender reference number and tender name**. (Do not provide additional copies per lot).
- 3.17 The submitted tender shall be typed or written in indelible ink and shall be signed by a person or persons duly authorised to sign on behalf of the tenderer, pursuant to Clause 1.5 (a) or 1.6 (b), as the case may be. All pages of the tender where alterations or additions have been made shall be initialled by the person or persons signing the tender.
- 3.18 Clarification of tenders shall be made during the Pre-bid conference to be held on **Thursday 29th August 2024 starting 9 a.m. to 10 a.m.**
- 3.19 The tender security shall be in the amount of **Kshs 1,000,000.00**.
4. Submission of Tenders.
- 4.1 The tenderer shall seal the original of the tender in one envelope, duly marked. The envelope shall:
- (a) be addressed to the Employer at the address provided in the invitation to tender;
 - (b) bear the tender name and tender reference number of the Contract as defined in the invitation to tender; and
 - (c) provide a warning not to open before the specified time and date for tender opening.
- 4.2 Tenders shall be delivered to the Employer at the address specified above not later than the time and date specified in the invitation to tender. However, the Employer may extend the deadline for submission of tenders by issuing an amendment in accordance with Sub-Clause 2.4 in which case

all rights and obligations of the Employer and the tenderers previously subject to the original deadline will then be subject to the new deadline.

- 4.3 Any tender received after the deadline prescribed in clause 4.2 will be returned to the tenderer unopened.
- 4.4 Tenderers may modify or withdraw their tenders by giving notice in writing before the deadline prescribed in clause 4.2. Each tenderer's modification or withdrawal notice shall be prepared, sealed, marked, and delivered in accordance with clause 3.15 and 4.1, with the outer and inner envelopes additionally marked "MODIFICATION" and "WITHDRAWAL", as appropriate. No tender may be modified after the deadline for submission of tenders.
- 4.5 Withdrawal of a tender between the deadline for submission of tenders and the expiration of the period of tender validity specified in the invitation to tender or as extended pursuant to Clause 3.8 may result in the forfeiture of the Tender Security pursuant to Clause 3.13.
- 4.6 Tenderers may only offer discounts to, or otherwise modify the prices of their tenders by submitting tender modifications in accordance with Clause 4.4 or be included in the original tender submission.
5. Tender Opening and Evaluation
 - 5.1 The tenders will be opened by the Employer, including modifications made pursuant to Clause 4.4, in the presence of the tenderers' representatives who choose to attend at the time and in the place specified in the invitation to tender. Envelopes marked "WITHDRAWAL" shall be opened and read out first. Tenderers' and Employer's representatives who are present during the opening shall sign a register evidencing their attendance.
 - 5.2 The tenderers' names and proof of purchase of each tender and any alternative tender (if alternatives have been requested or permitted), tender modifications and withdrawals, and such other details as may the Employer, at its discretion may consider appropriate will be announced at the opening. The Employer shall prepare a tender opening report.
 - 5.3 Information relating to the examination, clarification, evaluation, and comparison of tenders and recommendations for the award of Contract shall not be disclosed to tenderers or any other third parties out of the context of the evaluation committee until the award to the successful tenderer has been announced. Any effort by a tenderer to influence the Employer's officials, processing of tenders or award decisions shall result in the rejection of his tender.
 - 5.4 To assist in the examination, evaluation, and comparison of tenders, the Employer at his discretion, may ask any tenderer for clarification of the tender, including breakdowns of unit rates. The request for clarification and the response shall be in writing or email but no change in the price or substance of the tender shall be sought, offered, or permitted except as required to confirm the correction of arithmetic errors discovered in the evaluation of the tenders in accordance with Clause 5.7.
 - 5.5 Prior to the detailed evaluation of tenders, the Employer will determine whether each tender (a) meets the eligibility criteria defined in Clause 1.7;(b) has been properly signed; (c) is accompanied by the required securities; and (d) is substantially responsive to the requirements of the tendering documents. A substantially responsive tender is one which conforms to all the terms, conditions and specifications of the tendering documents, without material deviation or reservation. A material deviation or reservation is one (a) which affects in any substantial way the scope, quality, or performance of the works; (b) which limits in any substantial way, inconsistent with the

tendering documents, the Employer's rights or the tenderer's obligations under the Contract; or
(c) whose rectification would affect unfairly the competitive position of other tenderers presenting substantially responsive tenders.

5.6 If a tender is not substantially responsive, it will be rejected, and may not subsequently be made responsive by correction or withdrawal of the nonconforming deviation or reservation.

5.7 Tenders determined to be substantially responsive will be checked for any arithmetic errors. Errors will be corrected as follows:

- (a) where there is a discrepancy between the amount in figures and the amount in words, the amount in words will prevail; and
- (b) where there is a discrepancy between the unit rate and the line item total resulting from multiplying the unit rate by the quantity, the unit rate as quoted will prevail, unless in the opinion of the Employer, there is an obvious typographical error, in which case the adjustment will be made to the entry containing that error.
- (c) In the event of a discrepancy between the tender amount as stated in the Form of Tender and the corrected tender figure in the main summary of the Bill of Quantities, the amount as stated in the Form of Tender shall prevail.
- (d) The Error Correction Factor shall be computed by expressing the difference between the tender amount and the corrected tender sum as a percentage of the corrected Work (i.e. Corrected tender sum less Prime Cost and Provisional Sums).
- (e) The Error Correction Factor shall be applied to all Works (as a rebate or addition as the case may be) for the purposes of valuations for Interim Certificates and valuation of variations.
- (f) the amount stated in the tender will be adjusted in accordance with the above procedure for the correction of errors and, with concurrence of the tenderer, shall be considered as binding upon the tenderer. If the tenderer does not accept the corrected amount, the tender may be rejected and the Tender Security may be forfeited in accordance with clause 3.13.

5.8 The Employer will evaluate and compare only the tenders determined to be substantially responsive in accordance with Clause 5.5.

5.9 In evaluating the tenders, the Employer will determine for each tender the evaluated tender price by adjusting the tender price as follows:

- (a) making any correction for errors pursuant to clause 5.7;
- (b) excluding provisional sums and the provision, if any, for contingencies in the Bill of Quantities, but including Dayworks where priced competitively.
- (c) making an appropriate adjustment for any other acceptable variations, deviations, or alternative offers submitted in accordance with clause 3.14; and

- (d) making appropriate adjustments to reflect discounts or other price modifications offered in accordance with clause 4.6.
- 5.10 The Employer reserves the right to accept or reject any variation, deviation, or alternative offer. Variations, deviations, and alternative offers and other factors which are in excess of the requirements of the tender documents or otherwise result in unsolicited benefits for the Employer will not be taken into account in tender evaluation.
- 5.11 The tenderer shall not influence the Employer on any matter relating to his tender from the time of the tender opening to the time the Contract is awarded. Any effort by the Tenderer to influence the Employer or his employees in his decision on tender evaluation, tender comparison or Contract award may result in the rejection of the tender.
- 5.12 Firms incorporated in Kenya where indigenous Kenyans own 51% or more of the share capital shall be allowed a 10% preferential bias provided that they do not sub-contract work valued at more than 50% of the Contract Price excluding Provisional Sums to a non-indigenous sub-contractor.
6. Award of Contract
- 6.1 Subject to Clause 6.2, the award of the Contract will be made to the tenderer whose tender has been determined to be substantially responsive to the tendering documents and who has offered the lowest evaluated tender price, provided that such tenderer has been determined to be (a) eligible in accordance with the provision of Clauses 1.2, and (b) qualified in accordance with the provisions of clause 1.7 and 1.8.
- 6.2 Notwithstanding clause 6.1 above, the Employer reserves the right to accept or reject any tender, and to cancel the tendering process and reject all tenders, at any time prior to the award of Contract, without thereby incurring any liability to the affected tenderer or tenderers or any obligation to inform the affected tenderer or tenderers of the grounds for the action.
- 6.3 The tenderer whose tender has been accepted will be notified of the award prior to expiration of the tender validity period in writing or email. This notification (hereinafter and in all Contract documents called the "Letter of Acceptance") will state the sum (hereinafter and in all Contract documents called the "Contract Price") that the Employer will pay the Contractor in consideration of the execution, completion, and maintenance of the Works by the Contractor as prescribed by the Contract. At the same time the other tenderers shall be informed that their tenders have not been successful. The contract shall be formed on the parties signing the contract.
- 6.4 The Agreement will incorporate all agreements between the Employer and the successful tenderer.
- 6.5 The LPO together with the contract will be sent to the successful tenderer if they acknowledge receipt and acceptance of the offer within 5 days following the date of notification of award. After receipt of the Letter of Acceptance, the successful tenderer shall deliver to the Employer a Performance Security in the amount stipulated in the Appendix to Conditions of Contract and in the form stipulated in the Tender documents. The Performance Security shall be in the amount and specified form.
- 6.6 Failure of the successful tenderer to comply with the requirements of clause 6.5 shall constitute sufficient grounds for cancellation of the award and forfeiture of the Tender Security.
- 6.7 Preference where allowed in the evaluation of tenders shall not be allowed for contracts not exceeding one year (12 months).

- 6.8 The tender evaluation shall be carried out within a maximum of 30 calendar days from the day of opening the tender.
 - 6.9 The parties to the contract shall have it signed within 30 days from the date of notification of contract award unless there is an administrative review request.
 - 6.10 Contract price variations shall not be allowed for contracts not exceeding one year (12 months).
 - 6.11 Where contract price variation is allowed, the valuation shall not exceed 15% of the original contract price.
 - 6.12 Price variation request shall be processed by the procuring entity within 14 days of receiving the request.
 - 6.13 The procuring entity may at any time terminate procurement proceedings before contract award and shall not be liable to any person for the termination.
 - 6.14 The procuring entity shall give prompt notice of the termination to the tenderers and on request give its reasons for termination within 14 days of receiving the request from any tenderer.
 - 6.15 A tenderer who gives false information in the tender document about its qualification or who refuses to enter into a contract after notification of contract award shall be considered for debarment from participating in future public procurement.
7. Corrupt and Fraudulent practices
 - 7.1 The procuring entity requires that tenderers observe the highest standards of ethics during procurement process and execution of contracts. A tenderer shall sign a declaration that he has not and will not be involved in corrupt and fraudulent practices.
8. Appeal Period
 - 8.1 Any vendor/service provider who wishes to appeal against the outcome of the tender shall do so in writing within 3 days of the date of the notification/regret letter. Any letter received after the third day shall not be responded to and shall be treated as null and void. Amref Health Africa shall have dispensed with this procurement.

SECTION III: Tender Evaluation Criteria

After tender opening, the tenders will be evaluated in 4 stages, namely:

1. Preliminary Evaluation
2. Technical Evaluation
3. Financial Evaluation
4. Due diligence

STAGE 1: Preliminary Evaluation

Bids will be evaluated based on the below criteria and the bids **lacking any of the documents** below will be considered as non-responsive and therefore will be eliminated at this stage.

PRELIMINARY EVALUATION OF MANDATORY REQUIREMENTS				
Mandatory Requirements				
No.	Particulars	Marks	Compliant	Non-compliant
1.	Copy of Certificate of Incorporation/Certificate of Registration.	1 or 0		
2.	Copy of valid KRA Tax Compliance certificate.	1 or 0		
3.	A current CR12 from the Registrar of Companies (generated within the last 12 months - as from July 2023 to date) or copies of identification cards for Sole Proprietors/Partnerships. (<i>Must Specify the shareholding</i>)	1 or 0		
4.	Must attach Mobile money deposit receipt/ original banking deposit slip as proof of purchase of tender documents (If applying for more than one LOT, provide specific payment for each LOT).	1 or 0		
5.	Must provide a copy of valid business Trading License relevant to this tender.	1 or 0		
6.	Must provide the following National Construction Authority certificates accompanied by the respective valid annual practicing licenses: <ul style="list-style-type: none"> ● Building works certificate (NCA 6 and above) and ● Mechanical Works certificate (NCA 6 and above). Foreign firms must provide; <ul style="list-style-type: none"> ● A letter of commitment to secure the building works certificate (NCA 6 and above) and Mechanical Works certificate (NCA 6 and above) if awarded the contract 	1 or 0		
7.	Must provide tender security from a reputable bank amounting to Kshs 1,000,000.00 (Original Tender security must be attached.) valid until the date specified in the form of tender security.	1 or 0		
8.	Must submit copies of the most recent 2 years audited financial reports (not older than 2021) and each must be signed by the auditor and the firms Directors. (Both reports must have unqualified/ unmodified auditor's opinion).	1 or 0		
9.	ENSURE that all pages are sequentially paginated in the format 1, 2,3.... starting with 1 on top page (<i>see details of pagination and binding on sections 8.2 and 8.3 under specific instructions of the tender document</i>).	1 or 0		

Note: All the above documents numbered 1 to 9 should be packaged and arranged in that order under the preliminary evaluation criteria section of the tender document.

STAGE 2: Technical Evaluation

The tender document shall be examined based on clause 2.2 of the Instruction to Tenderers which states as follows:

1. In accordance with clause 2.2 of Instruction to Tenderers, the tenderers will be required to provide evidence for eligibility of the award of the tender by satisfying the employer of their eligibility under sub clause 2.1 of Instructions to Tenderers and their capability and adequacy of resources to effectively carry out the subject contract.
2. In order to comply with provisions of clause 2.2 of Instruction to Tenderers, the tenderers shall be required;
 - a) To fill the Standard Forms provided in the bid document for the purposes of providing the required information. The tenderers may also attach the required information if they so desire;
 - b) To supply equipment/items which comply with the technical specifications set out in the bid document. In this regard, the bidders shall be required to submit relevant technical brochures/catalogues with the tender document, highlighting the Catalogue Numbers of the proposed items. Such brochures/catalogues should indicate comprehensive relevant data of the proposed equipment/items which should include but not limited to the following:
 - (i) Standards of manufacture;
 - (ii) Performance ratings/characteristics;
 - (iii) Material of manufacture;
 - (iv) Electrical power ratings;
 - (v) Proof of CE Certification of the product; and
 - (vi) Any other necessary requirements (Specify).

The bid will then be analysed, using the information in the technical brochures, to determine compliance with General and Particular technical specifications for the works as indicated in the tender document. The tenderer shall also fill in the Technical Schedule as specified in the tender document for Equipment and Items indicating the Country of Origin, Model/Make/Manufacturer and catalogue numbers of the Items/Equipment they propose to supply.

Table 1: Technical Evaluation

Requirements		
<u>Detailed technical Specifications/ Description of requirements</u>		Max Score
1.	Compliance with Technical Specifications for the following key components; (Attach brochures and/or manuals from the manufacturer to support the specs below)	
	a) Manifold Fully automatic Medical Oxygen Gas Manifold system, complete with two stage regulators, monitoring alarm, manifold header with valve ports for cylinder hose connection. (with its cylinder holding rack as per BoQ)	Attach ISO certificates /compliance certificates/ conformity certificates from certifying bodies for the following ISO standards; <ul style="list-style-type: none"> ▪ ISO 7396-01:2016 ▪ ISO 13485:2016 ▪ ISO 15001:2010
	b) Cylinder pigtail hose - stainless steel, medical grade flexible braided pig tail hoses	Attach ISO certificate /compliance certificate/ conformity certificate from certifying body for ISO 21969:2009
	c) Pipes and piping accessories Degreased, seamless medical grade copper pipes	Attach ISO certificates /compliance certificates/ conformity certificates from certifying bodies for the following ISO standards; <ul style="list-style-type: none"> ▪ ISO 15001:2010 ▪ ISO 13485:2016 ▪ ISO 7396-01:2016 or BS EN 13348:2016
	d)Oxygen Outlets - wall mounted type With conformity to BS 5682 (attach brochure for reference)	Attach ISO certificate /compliance certificate/ conformity certificate from certifying body for ISO 9170-1:2017 standard.
2.	Provide a 2 Year Warranty specifying each of the following components; <ul style="list-style-type: none"> a) Manifold (1 or 0) b) Pipes and accessories ... (1 or 0) c) Oxygen Outlets.....(1 or 0) 	
3.	Manufacturers Guarantee	Provide Manufacturers Guarantee for spare parts availability for a period of 10 years from date of commissioning specifying the following components; <ul style="list-style-type: none"> ▪ Manifold (5 marks) ▪ Pipes & Accessories (5 marks) ▪ Outlets (5 marks)
4.	Maintenance	Provide detailed service and maintenance plan listing the parts, tools, spares and consumables to be used during the 2-year warranty period.

5.	Key Personnel	<p>Technical Personnel: Provide CVs and copies of certificate for;</p> <ol style="list-style-type: none"> 1. Engineer (Team Leader). (Qualification – Relevant University Degree/Higher National Diploma (Bio-medical engineering, Mechanical, Mechatronic, Electrical, Industrial) <ol style="list-style-type: none"> i. At least 7 years’ experience – (2 marks) ii. Less than 7 years’ experience – (1 mark) iii. No CV provided/Irrelevant Qualifications– (0 marks) 2. Biomedical Technologist (Qualification – Diploma in Bio-medical/medical engineering) <ol style="list-style-type: none"> i. At least 5 years’ experience – (5 marks) ii. Less than 5 years’ experience – (2 marks) iii. No CV provided/ Irrelevant Qualifications – (0 marks) 	7 Marks
6.		<p>Annual volume of construction (certified 2 most recent audited financial reports (from 2021);</p> <ol style="list-style-type: none"> I. Average Annual Turn-over equal or greater than the cost of the project. (5 marks) II. Average Annual Turn-over above 50% but below 100% of the cost of the project - (3 marks) III. Average Annual Turn-over below 50% of the cost of the project (1 mark) 	5 Marks
7.	Delivery Schedule	<p>Attach a delivery schedule specifying the lead time for supply, installation and commissioning of the medical oxygen piping infrastructure for all facilities in this lot.</p> <ol style="list-style-type: none"> i. 24 weeks or less (5 marks) ii. More than 24 weeks (2 marks) iii. Not specified (0 mark) 	5 Marks
8.	Proof of Supply and Works	<p>Provide proof of supply, installation and/or commissioning of oxygen related works, piping and fittings within the last 5 years – 2019 to date specifying the value (<i>purchase orders/invoices/contracts/ completion certificates</i>)</p> <ol style="list-style-type: none"> i. Above Kshs. 20M – (10 marks) ii. Above Kshs 10M up to Kshs 20M - (7marks) iii. Orders below Kshs 10M – (4 marks) iv. No proof of supply/irrelevant – (0 mark) 	10 Marks

Any bidder who scores **65 Marks** and above out of **80 Marks** shall be considered for further evaluation.

STAGE 3: Financial Evaluation

Upon completion of the technical evaluation a detailed financial evaluation shall follow.

The evaluation shall be in three stages;

- a) Determination of Arithmetic errors
- b) Comparison of Rates; and
- c) Consistency of the Rates.

(a) Determination of Arithmetic Errors

Arithmetic Errors will be corrected by the Procuring Entity as follows:

- i. In the event of a discrepancy between the tender amount as stated in the form of Tender and the corrected tender figure in the Main summary of the Bills of Quantities, the amount as stated in the Form of Tender shall prevail. Pursuant to Section 82 of the Public Procurement and Asset Disposal Act 2015, the tender sum as submitted and read out during the tender opening shall be absolute and final and shall not be the subject of correction, adjustment or amendment in any way by any person or entity;
- ii. Error correction factor shall be computed by expressing the difference between the amount and the corrected tender sum as a percentage of the corrected contract works (i.e. corrected tender sum less P.C; and Provisional Sums);
- iii. The Error correction factor shall be applied to all contract works (as a rebate or addition as the case may be) for the purposes of valuations for Interim Certificates and valuation of variations.

(b) Comparison of rates

Items that are underpriced or overpriced may indicate potential for non-delivery and front loading respectively. The committee shall promptly write to the tenderer asking for detailed breakdown of costs for any of the quoted items, relationship between those prices, proposed construction/installation methods and schedules.

The evaluation committee shall evaluate the responses and make an appropriate recommendation to the procuring entity giving necessary evidence. Such recommendations may include but not limited to:

- i. Recommend no adverse action to the tenderer after a convincing response;
- ii. Employer requiring that the amount of the performance bond be raised at the expense of the successful tenderer to a level sufficient to protect the employer against potential financial losses;
- iii. Recommend non-award based on the response provided and the available demonstrable evidence that the scope, quality, completion timing, administration of works to be undertaken by the tenderer, would adversely be affected or the rights of the employer or the tenderers obligations would be limited in a substantial way.

(c) Consistency of the Rates

The evaluation committee will compare the consistency of rates for similar items and note all inconsistencies of the rates for similar items.

STAGE 4 – Due Diligence

The Evaluation Committee shall subject shortlisted bidder(s) considered for award for due diligence check prior to award.

SECTION IV: Conditions of Contract

1 Definitions

- 1.1 In this Contract, except where context otherwise requires, the following terms shall be interpreted as indicated;

“Bill of Quantities” means the priced and completed Bill of Quantities forming part of the tender.

“Compensation Events” are those defined in Clause 24 hereunder.

“The Completion Date” means the date of completion of the Works as certified by the Project Manager, in accordance with Clause 31.

“The Contract” means the agreement entered into between the Employer and the Contractor as recorded in the Agreement Form and signed by the parties including all attachments and appendices thereto and all documents incorporated by reference therein to execute, complete, and maintain the Works,

“The Contractor” refers to the person or corporate body whose tender to carry out the Works has been accepted by the Employer.

“The Contractor’s Tender” is the completed tendering document submitted by the Contractor to the Employer.

“The Contract Price” is the price stated in the Letter of Acceptance and thereafter as adjusted in accordance with the provisions of the Contract.

“Days” are calendar days; “Months” are calendar months.

“A Defect” is any part of the Works not completed in accordance with the Contract.

“The Defects Liability Certificate” is the certificate issued by Project Manager upon correction of defects by the Contractor.

“The Defects Liability Period” is the period named in the Contract Data and calculated from the Completion Date.

“Drawings” include calculations and other information provided or approved by the Project Manager for the execution of the Contract.

“Dayworks” are Work inputs subject to payment on a time basis for labour and the associated materials and plant.

“Client”, or the “Procuring entity” as defined in the Public Procurement Regulations (i.e. National or County Government administration, Universities, Public Institutions and Corporations, etc) is the party who employs the Contractor to carry out the Works.

“Equipment” is the Contractor’s machinery and vehicles brought temporarily to the Site for the execution of the Work.

“The Intended Completion Date” is the date on which it is intended that the Contractor shall complete the Works. The Intended Completion Date may be revised only by the Project Manager by issuing an extension of time or an acceleration order.

“Materials” are all supplies, including consumables, used by the Contractor for incorporation in the Works.

“Plant” is any integral part of the Works that shall have a mechanical, electrical, chemical, or biological function.

“Project Manager” is the person named in the Appendix to Conditions of Contract (or any other competent person appointed by the Employer and notified to the Contractor, to act in replacement of the Project Manager) who is responsible for supervising the execution of the Works and administering the Contract.

“Site” is the area defined as such in the Appendix to Condition of Contract.

“Site Investigation Reports” are those reports that may be included in the tendering documents which are factual and interpretative about the surface and subsurface conditions at the Site.

“Specifications” means the Specifications of the Works included in the Contract and any modification or addition made or approved by the Project Manager.

“Start Date” is the latest date when the Contractor shall commence execution of the Works. It does not necessarily coincide with the Site possession date(s).

“A Subcontractor” is a person or corporate body who has a Contract with the Contractor to carry out a part of the Work in the Contract, which includes Work on the Site.

“Temporary works” are works designed, constructed, installed, and removed by the Contractor which are needed for construction or installation of the Works.

“A Variation” is an instruction given by the Project Manager which varies the Works.

“The Works” are what the Contract requires the Contractor to construct, install, and turnover to the Employer, as defined in the Appendix to Conditions of Contract.

2 Interpretation

- 2.1 In interpreting these Conditions of Contract, singular also means plural, male also means female or neuter, and the other way around. Headings have no significance. Words have their normal meaning in English Language unless specifically defined. The Project Manager will provide instructions clarifying queries about these Conditions of Contract.
- 2.2 If sectional completion is specified in the Appendix to Conditions of Contract, reference in the Conditions of Contract to the Works, the Completion Date and the Intended Completion Date apply to any section of the Works (other than references to the Intended Completion Date for the whole of the Works).

- 2.3 The following documents shall constitute the Contract documents and shall be interpreted in the following order of priority;
- i. Agreement,
 - ii. Letter of Acceptance,
 - iii. Contractor's Tender,
 - iv. Appendix to Conditions of Contract,
 - v. Conditions of Contract,
 - vi. Specifications,
 - vii. Bill of Quantities,
 - viii. Any other documents listed in the Appendix to Conditions of Contract as forming part of the Contract.

2.4 Immediately after the execution of the Contract, the Project Manager shall furnish both the Client and the Contractor with two copies each of all the Contract documents. Further, as and when necessary the Project Manager shall furnish the Contractor [always with a copy to the Client] with three [3] copies of such further details or descriptive schedules as are reasonably necessary either to enable the Contractor to carry out and complete the Works in accordance with these Conditions.

3 Language and Law

3.1 Language of the Contract and the law governing the Contract shall be English language and the Laws of Kenya respectively unless otherwise stated.

4 Project Manager's Decisions

4.1 Except where otherwise specifically stated, the Project Manager will decide contractual matters between the Employer and the Contractor in the role representing the Employer.

5 Delegation

5.1 The Project Manager may delegate any of his duties and responsibilities to others after notifying the Contractor.

6 Communications

6.1 Communication between parties shall be effective only when in writing. A notice shall be effective only when it is delivered.

7 Subcontracting

7.1 The Contractor may subcontract with the approval of the Project Manager, but may not assign the Contract without the approval of the Employer in writing. Subcontracting shall not alter the Contractor's obligations.

8 Other Contractors

8.1 The Contractor shall cooperate and share the Site with other contractors, public authorities, utilities etc. as listed in the Appendix to Conditions of Contract and also with the Employer, as per the directions of the Project Manager. The Contractor shall also provide facilities and services

for them. The Employer may modify the said List of Other Contractors etc., and shall notify the Contractor of any such modification.

9 Personnel

- 9.1 The Contractor shall employ the key personnel named in the Qualification Information, to carry out the functions stated in the said Information or other personnel approved by the Project Manager. The Project Manager will approve any proposed replacement of key personnel only if their relevant qualifications and abilities are substantially equal to or better than those of the personnel listed in the Qualification Information. If the Project Manager asks the Contractor to remove a person who is a member of the Contractor's staff or work force, stating the reasons, the Contractor shall ensure that the person leaves the Site immediately days and has no further connection with the Work in the Contract.

10 Works

- 10.1 The Contractor shall construct and install the Works in accordance with the Specifications and Drawings. The Works may commence on the Start Date and shall be carried out in accordance with the Program submitted by the Contractor, as updated with the approval of the Project Manager, and complete them by the Intended Completion Date.

11 Safety and Temporary Works

- 11.1 The Contractor shall be responsible for the design of temporary works. However before erecting the same, he shall submit his designs including specifications to the Project Manager and to any other relevant third parties for their approval. No erection of temporary works shall be done until such approvals are obtained.
- 11.2 The Project Manager's approval shall not alter the Contractor's responsibility for design of the Temporary works prepared by the Contractor for the execution of the temporary or permanent Works, shall be subject to prior approval by the Project Manager before they can be used.
- 11.3 The Contractor shall be responsible for the safety of all activities on the Site.
- 11.4 Occupational Safety and Health Administration (OSHA). The Contractor will be required to comply with OSHA requirements during installation works. The Contractor will be required to provide risk assessment and safety methods statements prior to work commencement.

12 Discoveries

- 12.1 Anything of historical or other interest or of significant value unexpectedly discovered on Site shall be the property of the Employer. The Contractor shall notify the Project Manager of such discoveries and carry out the Project Manager's instructions for dealing with them.

13 Work Program

- 13.1 Within the time stated in the Appendix to Conditions of Contract, the Contractor shall submit to the Project Manager for approval a program showing the general methods, arrangements, order, and timing for all the activities in the Works. An update of the program shall be a program showing the actual progress achieved on each activity and the effect of the progress achieved on the timing of the remaining Work, including any changes to the sequence of the activities.

13.2 The Contractor shall submit to the Project Manager for approval an updated program at intervals no longer than the period stated in the Appendix to Conditions of Contract. If the Contractor does not submit an updated program within this period, the Project Manager may withhold the amount stated in the said Appendix from the next payment certificate and continue to withhold this amount until the next payment after the date on which the overdue program has been submitted. The Project Manager's approval of the program shall not alter the Contractor's obligations. The Contractor may revise the program and submit it to the Project Manager again at any time. A revised program shall show the effect of Variations and Compensation Events.

14 Possession of Site

14.1 The Employer shall give possession of all parts of the Site to the Contractor. If possession of a part is not given by the date stated in the Appendix to Conditions of Contract, the Employer will be deemed to have delayed the start of the relevant activities, and this will be a Compensation Event.

15 Access to Site

15.1 The Contractor shall allow the Project Manager and any other person authorized by the Project Manager, access to the Site and to any place where work in connection with the Contract is being carried out or is intended to be carried out.

16 Instructions

16.1 The Contractor shall carry out all instructions of the Project Manager which are in accordance with the Contract.

17 Extension or Acceleration of Completion Date

17.1 The Project Manager shall extend the Intended Completion Date if a Compensation Event occurs or a variation is issued which makes it impossible for completion to be achieved by the Intended Completion Date without the Contractor taking steps to accelerate the remaining Work, which would cause the Contractor to incur additional cost. The Project Manager shall decide whether and by how much to extend the Intended Completion Date within 21 days of the Contractor asking the Project Manager in writing for a decision upon the effect of a Compensation Event or variation and submitting full supporting information. If the Contractor has failed to give early warning of a delay or has failed to cooperate in dealing with a delay, the delay caused by such failure shall not be considered in assessing the new (extended) Completion Date.

17.2 No bonus for early completion of the Works shall be paid to the Contractor by the Employer.

18 Management Meetings

18.1 A Contract management meeting shall be held monthly and attended by the Project Manager and the Contractor. Its business shall be to review the plans for the remaining Work and to deal with matters raised in accordance with the early warning procedure. The Project Manager shall record the minutes of management meetings and provide copies of the same to those attending the meeting and the Employer. The responsibility of the parties for actions to be taken shall be decided by the Project Manager either at the management meeting or after the management meeting and stated in writing to all who attended the meeting.

19 Early Warning

- 19.1 The Contractor shall warn the Project Manager at the earliest opportunity of specific likely future events or circumstances that may adversely affect the quality of the Work, increase the Contract Price or delay the execution of the Works. The Project Manager may require the Contractor to provide an estimate of the expected effect of the future event or circumstance on the Contract Price and Completion Date. The estimate shall be provided by the Contractor as soon as reasonably possible.
- 19.2 The Contractor shall cooperate with the Project Manager in making and considering proposals on how the effect of such an event or circumstance can be avoided or reduced by anyone involved in the Work and in carrying out any resulting instructions of the Project Manager.

20 Defects

- 20.1 The Project Manager shall inspect the Contractor's work and notify the Contractor of any defects that are found. Such inspection shall not affect the Contractor's responsibilities. The Project Manager may instruct the Contractor to search for a defect and to uncover and test any Work that the Project Manager considers may have a defect. Should the defect be found, the cost of uncovering and making good shall be borne by the Contractor, However, if there is no defect found, the cost of uncovering and making good shall be treated as a variation and added to the Contract Price.
- 20.2 The Project Manager shall give notice to the Contractor of any defects before the end of the Defects Liability Period, which begins at Completion, and is defined in the Appendix to Conditions of Contract. The Defects Liability Period shall be extended for as long as defects remain to be corrected.
- 20.3 Every time notice of a defect is given, the Contractor shall correct the notified defect within the length of time specified by the Project Manager's notice. If the Contractor has not corrected a defect within the time specified in the Project Manager's notice, the Project Manager will assess the cost of having the defect corrected by other parties and such cost shall be treated as a variation and be deducted from the Contract Price.

21 Bills of Quantities

- 21.1 The Bills of Quantities shall contain items for the construction, installation, testing and commissioning of the Work to be done by the Contractor. The Contractor will be paid for the quantity of the Work done at the rate in the Bills of Quantities for each item.
- 21.2 If the final quantity of the Work done differs from the quantity in the Bills of Quantities for the particular item by more than 25 percent and provided the change exceeds 1 percent of the Initial Contract price, the Project Manager shall adjust the rate to allow for the change.
- 21.3 If requested by the Project Manager, the Contractor shall provide the Project Manager with a detailed cost breakdown of any rate in the Bills of Quantities.

22 Variations

- 22.1 All variations shall be included in updated programs produced by the Contractor.

- 22.2 The Contractor shall provide the Project Manager with a quotation for carrying out the variations when requested to do so. The Project Manager shall assess the quotation, which shall be given within seven days of the request or within any longer period as may be stated by the Project Manager and before the Variation is ordered.
- 22.3 If the work in the variation corresponds with an item description in the Bills of Quantities and if in the opinion of the Project Manager, the quantity of work is not above the limit stated in Clause 21.2 or the timing of its execution does not cause the cost per unit of quantity to change, the rate in the Bills of Quantities shall be used to calculate the value of the variation. If the cost per unit of quantity changes, or if the nature or timing of the work in the variation does not correspond with items in
- 22.4 The Bills of Quantities, the quotation by the Contractor shall be in the form of new rates for the relevant items of Work.
- 22.5 If the Contractor's quotation is unreasonable, the Project Manager may order the variation and make a change to the Contract price, which shall be based on the Project Manager's own forecast of the effects of the variation on the Contractor's costs.
- 22.6 If the Project Manager decides that the urgency of varying the Work would prevent a quotation being given and considered without delaying the Work, no quotation shall be given and the variation shall be treated as a Compensation Event.
- 22.7 The Contractor shall not be entitled to additional payment for costs that could have been avoided by giving early warning.
- 22.8 When the Program is updated, the Contractor shall provide the Project Manager with an updated cash flow forecast.

23 Payment Certificates, Currency of Payments and Advance Payments

- 23.1 The Contractor shall submit to the Project Manager monthly applications for payment giving sufficient details of the Work done and materials on Site and the amounts which the Contractor considers himself to be entitled to. The Project Manager shall check the monthly application and certify the amount to be paid to the Contractor within 14 days. The value of Work executed and payable shall be determined by the Project Manager.
- 23.2 The value of Work executed shall comprise the value of the quantities of the items in the Bills of Quantities completed, materials delivered on Site, variations and compensation events. Such materials shall become the property of the Employer once the Employer has paid the Contractor for their value. Thereafter, they shall not be removed from Site without the Project Manager's instructions except for use upon the Works.
- 23.3 Payments shall be adjusted for deductions for retention. The Employer shall pay the Contractor the amounts certified by the Project Manager within 30 days of the date of issue of each certificate. If the Employer makes a late payment, the Contractor shall be paid simple interest on the late payment in the next payment. Interest shall be calculated on the basis of number of days

delayed at a rate three percentage points above the Central Bank of Kenya's average rate for base lending prevailing as of the first day the payment becomes overdue.

- 23.4 If an amount certified is increased in a later certificate or as a result of an award by an Arbitrator, the Contractor shall be paid interest upon the delayed payment as set out in this clause. Interest shall be calculated from the date upon which the increased amount would have been certified in the absence of dispute.
- 23.5 Items of the Works for which no rate or price has been entered in will not be paid for by the Employer and shall be deemed covered by other rates and prices in the Contract.
- 23.6 The Contract Price shall be stated in Kenya Shillings. All payments to the Contractor shall be made in Kenya Shillings and foreign currency in the proportion indicated in the tender, or agreed prior to the execution of the Contract Agreement and indicated therein. The rate of exchange for the calculation of the amount of foreign currency payment shall be the rate of exchange indicated in the Appendix to Conditions of Contract. If the Contractor indicated foreign currencies for payment other than the currencies of the countries of origin of related goods and services, the Employer reserves the right to pay the equivalent at the time of payment in the currencies of the countries of such goods and services. The Employer and the Project Manager shall be notified promptly by the Contractor of any changes in the expected foreign currency requirements of the Contractor during the execution of the Works as indicated in the Schedule of Foreign Currency Requirements and the foreign and local currency portions of the balance of the Contract Price shall then be amended by agreement between Employer and the Contractor in order to reflect appropriately such changes.
- 23.7 In the event that an advance payment is granted, the following shall apply: -
- a) On signature of the Contract, the Contractor shall at his request, and without furnishing proof of expenditure, be entitled to an advance of 10% (ten percent) of the original amount of the Contract. The advance shall not be subject to retention money.
 - b) No advance payment may be made before the Contractor has submitted proof of the establishment of deposit or a directly liable guarantee satisfactory to the Employer in the amount of the advance payment. The guarantee shall be in the same currency as the advance.
 - c) Reimbursement of the lump sum advance shall be made by deductions from the Interim payments and where applicable from the balance owing to the Contractor. Reimbursement shall begin when the amount of the sums due under the Contract reaches 20% of the original amount of the Contract. It shall have been completed by the time 80% of this amount is reached.

The amount to be repaid by way of successive deductions shall be calculated by means of the formula:

$$R = \frac{A(x^1 - x^{11})}{x^1 - x^{11}}$$

Where:

R = the amount to be reimbursed

A = the amount of the advance which has been granted

X^1 = the amount of proposed cumulative payments as a percentage of the original amount of the Contract. This figure will exceed 20% but not exceed 80%.

X^{11} = the amount of the previous cumulative payments as a percentage of the original amount of the Contract. This figure will be below 80% but not less than 20%.

- a) with each reimbursement the counterpart of the directly liable guarantee may be reduced accordingly.

24 Compensation Events

24.1 The following issues shall constitute Compensation Events:

- a) The Employer does not give access to a part of the Site by the Site Possession Date stated in the Appendix to Conditions of Contract.
- b) The Employer modifies the List of Other Contractors, etc., in a way that affects the Work of the Contractor under the Contract.
- c) The Project Manager orders a delay or does not issue drawings, specifications or instructions required for execution of the Works on time.
- d) The Project Manager instructs the Contractor to uncover or to carry out additional tests upon the Work, which is then found to have no defects.
- e) The Project Manager unreasonably does not approve a subcontract to be let.
- f) Ground conditions are substantially more adverse than could reasonably have been assumed before issuance of the Letter of Acceptance from the information issued to tenderers (including the Site investigation reports), from information available publicly and from a visual inspection of the Site.
- g) The Project Manager gives an instruction for dealing with an unforeseen condition, caused by the Employer or additional work required for safety or other reasons.
- h) Other contractors, public authorities, utilities, or the Employer does not work within the dates and other constraints stated in the Contract, and they cause delay or extra cost to the Contractor.
- i) The effects on the Contractor of any of the Employer's risks.

- j) The Project Manager unreasonably delays issuing a Certificate of Completion.
- k) Other compensation events described in the Contract or determined by the Project Manager shall apply.

- 24.2 If a compensation event would cause additional cost or would prevent the Work being completed before the Intended Completion Date, the Contract Price shall be increased and/or the Intended Completion Date shall be extended. The Project Manager shall decide whether and by how much the Contract Price shall be increased and whether and by how much the Intended Completion Date shall be extended.
- 24.3 As soon as information demonstrating the effect of each compensation event upon the Contractor's forecast cost has been provided by the Contractor, it shall be assessed by the Project Manager, and the Contract Price shall be adjusted accordingly. If the Contractor's forecast is deemed unreasonable, the Project Manager shall adjust the Contract Price based on the Project Manager's own forecast. The Project Manager will assume that the Contractor will react competently and promptly to the event.
- 24.4 The Contractor shall not be entitled to compensation to the extent that the Employer's interests are adversely affected by the Contractor not having given early warning or not having co-operated with the Project Manager.
- 24.5 Prices shall be adjusted for fluctuations in the cost of inputs only if provided for in the Appendix to Conditions of Contract.
- 24.6 The Contractor shall give written notice to the Project Manager of his intention to make a claim within thirty days after the event giving rise to the claim has first arisen. The claim shall be submitted within thirty days thereafter provided always that should the event giving rise to the claim of continuing effect, the Contractor shall submit an interim claim within the said thirty days and a final claim within thirty days of the end of the event giving rise to the claim.

25 Price Adjustment

- 25.1 The Project Manager shall adjust the Contract Price if taxes, duties and other levies are changed between the date 30 days before the submission of tenders for the Contract and the date of Completion. The adjustment shall be the change in the amount of tax payable by the Contractor.
- 25.2 The Contract Price shall be deemed to be based on exchange rates current at the date of tender submission in calculating the cost to the Contractor of materials to be specifically imported (by express provisions in the Contract Bills of Quantities or Specifications) for permanent incorporation in the Works. Unless otherwise stated in the Contract, if at any time during the period of the Contract exchange rates shall be varied and this shall affect the cost to the Contractor of such materials, then the Project Manager shall assess the net difference in the cost of such materials. Any amount from time to time so assessed shall be added to or deducted from the Contract Price, as the case may be.

- 25.3 Unless otherwise stated in the Contract, the Contract Price shall be deemed to have been calculated in the manner set out below and in sub-clauses 25.4 and 25.5 and shall be subject to adjustment in the events specified thereunder;
- i. The prices contained in the Contract Bills of Quantities shall be deemed to be based upon the rates of wages and other emoluments and expenses as determined by the Joint Building Council of Kenya (J.B.C.) and set out in the schedule of basic rates issued 30 days before the date for submission of tenders. A copy of the schedule used by the Contractor in his pricing shall be attached in the Appendix to Conditions of Contract.
 - ii. Upon J.B.C. determining that any of the said rates of wages or other emoluments and expenses are increased or decreased, then the Contract Price shall be increased or decreased by the amount assessed by the Project Manager based upon the difference, expressed as a percentage, between the rate set out in the schedule of basic rates issued 30 days before the date for submission of tenders and the rate published by the J.B.C. and applied to the quantum of labour incorporated within the amount of Work remaining to be executed at the date of publication of such increase or decrease.
 - iii. No adjustment shall be made in respect of changes in the rates of wages and other emoluments and expenses which occur after the date of Completion except during such other period as may be granted as an extension of time under clause 17.0 of these Conditions.
- 25.4 The prices contained in the Contract Bills of Quantities shall be deemed to be based upon the basic prices of materials to be permanently incorporated in the Works as determined by the J.B.C. and set out in the schedule of basic rates issued 30 days before the date for submission of tenders. A copy of the schedule used by the Contractor in his pricing shall be attached in the Appendix to Conditions of Contract.
- 25.5 Upon the J.B.C. determining that any of the said basic prices are increased or decreased then the Contract Price shall be increased or decreased by the amount to be assessed by the Project Manager based upon the difference between the price set out in the schedule of basic rates issued 30 days before the date for submission of tenders and the rate published by the J.B.C. and applied to the quantum of the relevant materials which have not been taken into account in arriving at the amount of any interim certificate under clause 23 of these Conditions issued before the date of publication of such increase or decrease.
- 25.6 No adjustment shall be made in respect of changes in basic prices of materials which occur after the date for Completion except during such other period as may be granted as an extension of time under clause 17.0 of these Conditions. The provisions of sub-clause 25.1 to 25.2 herein shall not apply in respect of any materials included in the schedule of basic rates.

26 Retention

- 26.1 The Employer shall retain from each payment due to the Contractor the proportion stated in the Appendix to Conditions of Contract until Completion of the whole of the Works. On Completion of the whole of the Works, half the total amount retained shall be repaid to the Contractor and the remaining half when the Defects Liability Period has passed and the Project

Manager has certified that all defects notified to the Contractor before the end of this period have been corrected.

27 Liquidated Damages

- 27.1 The Contractor shall pay liquidated damages to the Employer at the rate stated in the Appendix to Conditions of Contract for each day that the actual Completion Date is later than the Intended Completion Date. The Employer may deduct liquidated damages from payments due to the Contractor. Payment of liquidated damages shall not alter the Contractor's liabilities.
- 27.2 If the Intended Completion Date is extended after liquidated damages have been paid, the Project Manager shall correct any overpayment of liquidated damages by the Contractor by adjusting the next payment certificate. The Contractor shall be paid interest on the overpayment, calculated from the date of payment to the date of repayment, at the rate specified in Clause 23.3.

28 Securities

- 28.1 The Performance Security shall be provided to the Employer no later than the date specified in the Letter of Acceptance and shall be issued in an amount and form and by a reputable bank acceptable to the Employer, and denominated in Kenya Shillings. The Performance Security shall be valid until a date at least 30 days beyond the date of issue of the Certificate of Completion.

29 Dayworks

- 29.1 If applicable, the Dayworks rates in the Contractor's tender shall be used for small additional amounts of Work only when the Project Manager has given written instructions in advance for additional work to be paid for in that way.
- 29.2 All work to be paid for as Dayworks shall be recorded by the Contractor on Forms approved by the Project Manager. Each completed form shall be verified and signed by the Project Manager within two days of the Work being done.
- 29.3 The Contractor shall be paid for Dayworks subject to obtaining signed Dayworks forms.

30 Liability and Insurance

- 30.1 From the Start Date until the Defects Correction Certificate has been issued, the following are the Employer's risks: The risk of personal injury, death or loss of or damage to property (excluding the Works, Plant, Materials and Equipment), which are due to;
- i. use or occupation of the Site by the Works or for the purpose of the Works, which is the unavoidable result of the Works, or
 - ii. negligence, breach of statutory duty or interference with any legal right by the Employer or by any person employed by or contracted to him except the Contractor.
 - iii. the risk of damage to the Works, Plant, Materials, and Equipment to the extent that it is due to a fault of the Employer or in Employer's design, or due to war or radioactive contamination directly affecting the place where the Works are being executed.

- 30.2 From the Completion Date until the Defects Correction Certificate has been issued, the risk of loss of or damage to the Works, Plant, and Materials is the Employer's risk except loss or damage due to;
- (a) a defect which existed on or before the Completion Date.
 - (b) an event occurring before the Completion Date, which was not itself the Employer's risk
 - (c) the activities of the Contractor on the Site after the Completion Date.
- 30.3 From the Start Date until the Defects Correction Certificate has been issued, the risks of personal injury, death and loss of or damage to property (including, without limitation, the Works, Plant, Materials, and Equipment) which are not Employer's risk are Contractor's risks.

The Contractor shall provide, in the joint names of the Employer and the Contractor, insurance cover from the Start Date to the end of the Defects Liability Period, in the amounts stated in the Appendix to Conditions of Contract for the following events;

- (a) loss of or damage to the Works, Plant, and Materials;
 - (b) loss of or damage to Equipment;
 - (c) loss of or damage to property (except the Works, Plant, Materials, and Equipment) in connection with the Contract, and
 - (d) personal injury or death.
- 30.4 Policies and certificates for insurance shall be delivered by the Contractor to the Project Manager for the Project Manager's approval before the Start Date. All such insurance shall provide for compensation required to rectify the loss or damage incurred.
- 30.5 If the Contractor does not provide any of the policies and certificates required, the Employer may effect the insurance which the Contractor should have provided and recover the premiums from payments otherwise due to the Contractor or, if no payment is due, the payment of the premiums shall be a debt due.
- 30.6 Alterations to the terms of an insurance shall not be made without the approval of the Project Manager. Both parties shall comply with any conditions of insurance policies. Completion and taking over upon deciding that the Works are complete, the Contractor shall issue a written request to the Project Manager to issue a Certificate of Completion of the Works. The Employer shall take over the Site and the Works within seven [7] days of the Project Manager's issuing a Certificate of Completion.

31 Final Account

- 31.1 The Contractor shall issue the Project Manager with a detailed account of the total amount that the Contractor considers payable to him by the Employer under the Contract before the end of the Defects Liability Period. The Project Manager shall issue a Defects Liability Certificate and certify any final payment that is due to the Contractor within 30 days of receiving the Contractor's account if it is correct and complete. If it is not, the Project Manager shall issue within 30 days a schedule that states the scope of the corrections or additions that are necessary. If the final account is still unsatisfactory after it has been resubmitted, the Project Manager shall decide on

the amount payable to the Contractor and issue a Payment Certificate. The Employer shall pay the Contractor the amount due in the Final Certificate within 60 days.

32 Termination

32.1 The Employer or the Contractor may terminate the Contract if the other party causes a fundamental breach of the Contract. These fundamental breaches of Contract shall include, but shall not be limited to, the following;

- (a) the Contractor stops work for 30 days when no stoppage of work is shown on the current program and the stoppage has not been authorized by the Project Manager;
- (b) the Project Manager instructs the Contractor to delay the progress of the Works, and the instruction is not withdrawn within 30 days;
- (c) the Contractor is declared bankrupt or goes into liquidation other than for a reconstruction or amalgamation;
- (d) a payment certified by the Project Manager is not paid by the Employer to the Contractor within 30 days (for Interim Certificate) or 60 days (for Final Certificate) of issue.
- (e) the Project Manager gives notice that failure to correct a particular defect is a fundamental breach of Contract and the Contractor fails to correct it within a reasonable period of time determined by the Project Manager;
- (f) the Contractor does not maintain a security, which is required.

32.2 When either party to the Contract gives notice of a breach of Contract to the Project Manager for a cause other than those listed under Clause 33.1 above, the Project Manager shall decide whether the breach is fundamental or not.

32.3 Notwithstanding the above, the Employer may terminate the Contract for convenience.

32.4 If the Contract is terminated, the Contractor shall stop work immediately, make the Site safe and secure, and leave the Site as soon as reasonably possible. The Project Manager shall immediately thereafter arrange for a meeting for the purpose of taking record of the Works executed and materials, goods, equipment and temporary buildings on Site.

33 Payment Upon Termination

33.1 If the Contract is terminated because of a fundamental breach of Contract by the Contractor, the Project Manager shall issue a certificate for the value of the Work done and materials ordered and delivered to Site up to the date of the issue of the certificate. Additional liquidated damages shall not apply. If the total amount due to the Employer exceeds any payment due to the Contractor, the difference shall be a debt payable by the Contractor.

33.2 If the Contract is terminated for the Employer's convenience or because of a fundamental breach of Contract by the Employer, the Project Manager shall issue a certificate for the value of the Work done, materials ordered, the reasonable cost of removal of equipment, repatriation of the Contractor's personnel employed solely on the Works, and the Contractor's costs of protecting and securing the Works.

- 33.3 The Employer may employ and pay other persons to carry out and complete the Works and to rectify any defects and may enter upon the Works and use all materials on the Site, plant, equipment and temporary works.
- 33.4 The Contractor shall, during the execution or after the completion of the Works under this clause remove from the Site as and when required, within such reasonable time as the Project Manager may in writing specify, any temporary buildings, plant, machinery, appliances, goods or materials belonging to or hired by him, and in default the Employer may (without being responsible for any loss or damage) remove and sell any such property of the Contractor, holding the proceeds less all costs incurred to the credit of the Contractor.
- 33.5 Until after completion of the Works under this clause the Employer shall not be bound by any other provision of this Contract to make any payment to the Contractor, but upon such completion as aforesaid and the verification within a reasonable time of the accounts therefore the Project Manager shall certify the amount of expenses properly incurred by the Employer and, if such amount added to the money paid to the Contractor before such determination exceeds the total amount which would have been payable on due completion in accordance with this Contract the difference shall be a debt payable to the Employer by the Contractor; and if the said amount added to the said money be less than the said total amount, the difference shall be a debt payable by the Employer to the Contractor.

34 Release from Performance

- 34.1 If the Contract is frustrated by the outbreak of war or by any other event entirely outside the control of either the Employer or the Contractor, the Project Manager shall certify that the Contract has been frustrated. The Contractor shall make the Site safe and stop Work as quickly as possible after receiving this certificate and shall be paid for all Work carried out before receiving it.

35 Corrupt gifts and payments of commission

- 35.1 The Contractor shall not;

(a) Offer or give or agree to give to any person in the service of the Employer any gift or consideration of any kind as an inducement or reward for doing or forbearing to do or for having done or forborne to do any act in relation to the obtaining or execution of this or any other Contract for the Employer or for showing or forbearing to show favour or disfavour to any person in relation to this or any other contract for the Employer.

(b) Enter into this or any other contract with the Employer in connection with which commission has been paid or agreed to be paid by him or on his behalf or to his knowledge, unless before the Contract is made particulars of any such commission and of the terms and conditions of any agreement for the payment thereof have been disclosed in writing to the Employer.

Any breach of this Condition by the Contractor or by anyone employed by him or acting on his behalf (whether with or without the knowledge of the Contractor) shall be an offence under the provisions of the Public Procurement Regulations issued under The Exchequer and Audit Act Cap 412 of the Laws of Kenya.

36 Settlement of Disputes

36.1 In case any dispute or difference shall arise between the Employer or the Project Manager on his behalf and the Contractor, either during the progress or after the completion or termination of the Works, such dispute shall be notified in writing by either party to the other with a request to submit it to arbitration and to concur in the appointment of an Arbitrator within thirty days of the notice. The dispute shall be referred to the arbitration and final decision of a person to be agreed between the parties. Failing agreement to concur in the appointment of an Arbitrator, the Arbitrator shall be appointed by the Chairman or Vice Chairman of any of the following professional institutions;

- (i) Architectural Association of Kenya
- (ii) Institute of Quantity Surveyors of Kenya
- (iii) Association of Consulting Engineers of Kenya
- (iv) Chartered Institute of Arbitrators (Kenya Branch)
- (v) Institution of Engineers of Kenya

On the request of the applying party. The institution written to first by the aggrieved party shall take precedence over all other institutions.

36.2 The arbitration may be on the construction of this Contract or on any matter or thing of whatsoever nature arising thereunder or in connection therewith, including any matter or thing left by this Contract to the discretion of the Project Manager, or the withholding by the Project Manager of any certificate to which the Contractor may claim to be entitled to or the measurement and valuation referred to in clause 23.0 of these conditions, or the rights and liabilities of the parties subsequent to the termination of Contract.

36.3 Provided that no arbitration proceedings shall be commenced on any dispute or difference where notice of a dispute or difference has not been given by the applying party within ninety days of the occurrence or discovery of the matter or issue giving rise to the dispute.

36.4 Notwithstanding the issue of a notice as stated above, the arbitration of such a dispute or difference shall not commence unless an attempt has in the first instance been made by the parties to settle such dispute or difference amicably with or without the assistance of third parties. Proof of such attempt shall be required.

36.5 Notwithstanding anything stated herein the following matters may be referred to arbitration before the practical completion of the Works or abandonment of the Works or termination of the Contract by either party:

36.6 The appointment of a replacement Project Manager upon the said person ceasing to act.

36.7 Whether or not the issue of an instruction by the Project Manager is empowered by these Conditions.

36.8 Whether or not a certificate has been improperly withheld or is not in accordance with these Conditions.

36.9 Any dispute or difference arising in respect of war risks or war damage.

- 36.10 All other matters shall only be referred to arbitration after the completion or alleged completion of the Works or termination or alleged termination of the Contract, unless the Employer and the Contractor agree otherwise in writing.
- 36.11 The Arbitrator shall, without prejudice to the generality of his powers, have powers to direct such measurements, computations, tests or valuations as may in his opinion be desirable in order to determine the rights of the parties and assess and award any sums which ought to have been the subject of or included in any certificate.
- 36.12 The Arbitrator shall, without prejudice to the generality of his powers, have powers to open up, review and revise any certificate, opinion, decision, requirement or notice and to determine all matters in dispute which shall be submitted to him in the same manner as if no such certificate, opinion, decision requirement or notice had been given.
- 36.13 The award of such Arbitrator shall be final and binding upon the parties.

SECTION V: Appendix to Conditions of Contract

The Client is:

Name: Amref Health Africa

Address: P.O. Box 30125 - 00100 Nairobi

The Project Manager is:

Name:

Address:

The name (and identification number) of the Contract is the PROPOSED SUPPLY, INSTALLATION, TESTING AND COMMISSIONING OF MEDICAL OXYGEN PIPING INFRASTRUCTURE AND RELATED MANIFOLD HOUSING CONSTRUCTION WORKS FOR VARIOUS FBO HEALTH FACILITIES IN KENYA - LOT ONE.

The Works consist of SUPPLY, INSTALLATION AND COMMISSIONING OF THE MEDICAL OXYGEN PIPING INFRASTRUCTURE AND RELATED MANIFOLD HOUSING CONSTRUCTION WORKS TO SUPPORT 10 HEALTH FACILITIES as per the specifications and Bills of Quantities.

The Start Date shall be agreed with the Project Manager.

The maximum Intended Completion Date for the whole of the Works shall not exceed **30 Weeks** after commencement date.

The following documents also form part of the Contract as listed in clause 2.1 of the Conditions of Contract.

The Contractor shall submit a revised program for the Works within 7 days of delivery of the Letter of Acceptance.

The Site Possession Date shall be agreed with the Project Manager.

The Defects Liability period will apply.

Other Contractors, utilities etc., to be engaged by the Client on the Site include those for the execution of; (Domestic Subcontractors must be registered with NCA and evidence of the same must be attached)

1. Plumbing and Drainage Works
2. Electrical Works

The minimum insurance covers shall be;

1. The minimum cover for insurance of the Works and of Plant and Materials in respect of the Contractor's faulty design is _____ Nil _____
2. The minimum cover for loss or damage to Equipment is _____ Nil
3. The minimum for insurance of other property is Kshs. 500,000.00
4. The minimum cover for personal injury or death insurance:
For the Contractor's employees is _Kshs. 500,000.00
And for other people is _____ Kshs. 1,000,000.00

The following events shall also be Compensation Events:

1. NONE OTHER THAN AS DEFINED IN THESE CONDITIONS OF CONTRACT
- 2.
- 3.
- 4.

The period between Program updates is 7 days.

The amount to be withheld for late submission of an updated Program is FULL CERTIFICATE

The proportion of payments retained is 10 percent (%).

The Price Adjustment Clause SHALL NOT apply.

The liquidated damages for the whole of the Works is Kshs. 10,000 [per Week].

The Performance Security shall be for the following minimum amounts equivalent as a percentage of the Contract Price 10 percent (%).

The Completion Period for the Works is 24 [Weeks].

The rate of exchange for calculation of foreign currency payments is NOT APPLICABLE

The schedule of basic rates used in pricing by the Contractor is as ISSUED BY THE JOINT BUILDING COUNCIL (JBC - KENYA) THIRTY DAYS BEFORE THE DATE OF SUBMISSION OF TENDERS

Advance Payment SHALL NOT APPLY.

The Bidder should submit only ONE (1 No.) set of the Bills of Quantities as indicated in clause 4.1 of the Instruction to Tenderers.

SECTION VI: Standard Forms

- 1) Form of Invitation for Tenders
- 2) Form of Tender
- 3) Letter of Award
- 4) Form of Agreement
- 5) Form of Tender Security
- 6) Performance Bank Guarantee
- 7) Bank Guarantee for Advance Payment
- 8) Qualification Information
- 9) Confidential Business Questionnaire
- 10) Details of Sub-Contractors

Form of Invitation for Tenders

_____ [date]

To: _____ [Name of Contractor]

_____ [Address of Contractor]

Dear Sirs:

Reference _____ [Contract Name]

You have been prequalified to tender for the above project.

We hereby invite you and other prequalified tenderers to submit a tender for the execution and completion of the above Contract.

A complete set of tender documents may be purchased by you from _____

[mailing address]

Upon payment of a non-refundable fee of Kshs _____

All tenders must be accompanied by _____ number of copies of the same and a security in the form and amount specified in the tendering documents, and must be delivered to

[address and location]

at or before _____

[time and date]

Tender will be opened immediately thereafter, in the presence of tenderer's representatives who choose to attend.

Please confirm receipt of this letter immediately in writing by email.

Yours faithfully,

_____ [Authorized Signature]

_____ [Name and Title]

Form of Tender

TO: **AMREF HEALTH AFRICA IN KENYA** [*Name of Client*]

_____ [*Date*]

_____ [*Name of Contract*]

Dear Sir,

1. In accordance with the Conditions of Contract, Specifications, Drawings and Bills of Quantities for the execution of the above named Works, we, the undersigned offer to construct, install and complete such Works and remedy any defects therein for the sum of Kshs. _____ [*Amount in figures*] Kenya Shillings _____

_____ [*Amount in words*]

We undertake, if our tender is accepted, to commence the Works as soon as is reasonably possible after the receipt of the Project Manager's notice to commence, and to complete the whole of the Works comprised in the Contract within the time stated in the Appendix to Conditions of Contract.

We agree to abide by this tender until _____ [*Insert date*], and it shall remain binding upon us and may be accepted at any time before that date.

Unless and until a formal Agreement is prepared and executed this tender together with your written acceptance thereof, shall constitute a binding Contract between us.

We understand that you are not bound to accept the lowest or any tender you may receive.

Dated this _____ day of _____ 20 _____

Signature _____ in the capacity of _____ duly

authorized to sign tenders for and on behalf of _____

_____ [*Name of Employer*] of _____ [*Address*

of Employer]

Witness; Name _____

Address _____

Signature _____

Date _____

Letter of Award

[letterhead paper of the Employer]

_____ [date]

To: _____
[name of the Contractor]

[address of the Contractor]

Dear Sir,

This is to notify you that your tender dated _____

[name of the Contract and tender number as given in the Tender documents]

for the Contract Price of Kshs. _____ [amount in figures] [Kenya Shillings]

[Amount in words] in accordance with the Instructions to Tenderers is hereby accepted.

You are hereby instructed to proceed with the execution of the said Works in accordance with the Contract documents.

Authorized Signature

Name and Title of Signatory

Attachment: Agreement

Form of Agreement

THIS AGREEMENT, made on the _____ day of ____ 20 _____ between _____ of [or whose registered office is situated at] _____ (hereinafter called “the Client”) of the one part

AND

_____ of [or whose registered office is situated at] _____ (hereinafter called “the Contractor”) of the other part.

WHEREAS THE Employer is desirous that the Contractor executes _____ (name and identification number of Contract) (hereinafter called “the Works”) located at _____ [Place/location of the Works] and the Client has accepted the tender submitted by the Contractor for the execution and completion of such Works and the remedying of any defects therein for the Contract Price of Kshs _____ [Amount in figures], Kenya Shillings _____ [Amount in words].

NOW THIS AGREEMENT WITNESSETH as follows:

1. In this Agreement, words and expressions shall have the same meanings as are respectively assigned to them in the Conditions of Contract hereinafter referred to.
2. The following documents shall be deemed to form and shall be read and construed as part of this Agreement i.e.
 - a) Letter of Acceptance Form of Tender
 - b) Conditions of Contract Part I
 - c) Conditions of Contract Part II and Appendix to Conditions of Contract Specifications
 - d) Priced Bills of Quantities
3. In consideration of the payments to be made by the Client to the Contractor as hereinafter mentioned, the Contractor hereby covenants with the Employer to execute and complete the Works and remedy any defects therein in conformity in all respects with the provisions of the Contract.
4. The Employer hereby covenants to pay the Contractor in consideration of the execution and completion of the Works and the remedying of defects therein, the Contract Price or such other sum as may become payable under the provisions of the Contract at the times and in the manner prescribed by the Contract.

IN WITNESS, WHEREOF the Parties have caused this Agreement to be executed by their duly appointed representatives on the date first above-mentioned.

For and on Behalf of:

[Contractor's Name]
[Contractors Address]

Name

Position

Signature

Witness Name

Witness Signature

Witness Name

Witness Signature

Place Company Stamp Here

For and on Behalf of:

[Clients Name]
[Contractors Address]

Name

Position

Signature

Witness Name

Witness Signature

Witness Name

Witness Signature

Place Company Stamp Here

Form of Tender Security

Tender No. Amref

PROPOSED SUPPLY, INSTALLATION, TESTING AND COMMISSIONING OF MEDICAL OXYGEN PIPING INFRASTRUCTURE AND RELATED MANIFOLD HOUSING CONSTRUCTION WORKS IN VARIOUS FBO HEALTH FACILITIES IN KENYA - LOT NO.1

To: Amref Health Africa

WHEREAS *[insert: name of Tenderer]* (hereinafter called “the Tenderer”) has submitted its tender dated *[insert: date of tender]* for the performance of the above-named Contract (hereinafter called “the Tender”)

KNOW ALL PERSONS by these present that WE *[insert: name of bank]* of *[insert: address of bank]* (hereinafter called “the Bank”) are bound unto *[insert: name of Purchaser]* (hereinafter called “the Purchaser”) in the sum of: *[insert: amount]*, for which payment well and truly to be made to the said Purchaser, the Bank binds itself, its successors and assigns by these presents.

Sealed with the Common Seal of the said Bank this *[insert: number]* day of *[insert: month]*, *[insert: year]*.

THE CONDITIONS of this obligation are the following:

1. If, after the tender submission deadline, the Tenderer
 - (a) withdraws its tender during the period of tender validity specified by the Tenderer in the Tender Form, or
 - (b) does not accept the Purchaser’s corrections of arithmetic errors in accordance with the Instructions to Tenderers; or
 - (c) does not at all reply to the Purchaser’s requests for clarification

2. If the Tenderer, having been notified of the acceptance of its tender by the Purchaser during the period of tender validity.
 - (a) Fails or refuses to sign the Contract Agreement when required; or
 - (b) Fails or refuses to issue the performance security in accordance with the Instructions to Tenderers.

We undertake to pay to the Purchaser up to the above amount upon receipt of its first written demand, without the Purchaser having to substantiate its demand, provided that in its demand the Purchaser will note that the amount claimed by it is due it, owing to the occurrence of any one of the two above-named CONDITIONS, and specifying the occurred condition or conditions.

This guarantee will remain in full force up to and including **Sunday 23rd February 2025**, and any demand in respect thereof must reach the Bank not later than the above date.

Note: A bidder who withdraws its tender after the deadline for submission will forfeit its bid security deposit

For and on behalf of the Bank

Signed: _____ Date: _____

Performance Bank Guarantee

To: _____
[Name of Client]

[Date]

[Address of Client]

Dear Sir,

WHEREAS _____ (hereinafter called "the Contractor") has undertaken, in pursuance of Contract No. _____ dated to Execute (hereinafter called "the Works");

AND WHEREAS it has been stipulated by you in the said Contract that the Contractor shall furnish you with a Bank Guarantee by a recognized bank for the sum specified therein as security for compliance with his obligations in accordance with the Contract;

AND WHEREAS we have agreed to give the Contractor such a Bank Guarantee:

NOW THEREFORE we hereby affirm that we are the Guarantor and responsible to you, on behalf of the Contractor, up to a total of Kshs (amount of Guarantee in figures) Kenya Shillings..... (amount of Guarantee in words) and we undertake to pay you, upon your first written demand and without cavil or argument, any sum or sums within the limits of Kenya Shillings..... (amount of Guarantee in words) as aforesaid without your needing to prove or to show grounds or reasons for your demand for the sum specified therein. We hereby waive the necessity of your demanding the said debt from the Contractor before presenting us with the demand.

We further agree that no change, addition or other modification of the terms of the Contract or of the Works to be performed thereunder or of any of the Contract documents which may be made between you and the Contractor shall in any way release us from any liability under this Guarantee, and we hereby waive notice of any change, addition, or modification.

This guarantee shall be valid until the date of issue of the Certificate of Completion.

SIGNATURE AND SEAL OF THE GUARANTOR _____

Name of Bank _____

Address _____

Date _____

Qualification Information

Individual Tenderers or Individual Members of Joint Ventures

1.1 Constitution or legal status of tenderer (attach copy or Incorporation Certificate);

Place of registration: _____

Principal place of business: _____

Power of attorney of signatory of tender: _____

1.2 Total annual volume of construction work performed in the last five years (2018 to date)

Year	Volume	
	Currency	Value

1.3 Work performed as Main Contractor on works of a similar nature and volume over the last five years. Also list details of work under way or committed, including expected completion date.

Project name	Name of the client and contact person	Type of work performed and year of completion	Value of Contract

1.4 Major items of Contractor’s Equipment proposed for carrying out the Works. List all information requested below.

Item of Equipment	Description, Make and age (years)	Condition (new, good, poor) and number available	Owned, leased (from whom?), or to be purchased (from whom?)
(etc.)			

1.5 Qualifications and experience of key personnel proposed for administration and execution of the Contract. Attach biographical data.

Position	Name	Years of experience (general)	Years of experience in proposed position

Project Manager etc.)			
-----------------------	--	--	--

1.6 Financial reports for the last TWO years: balance sheets, profit and loss statements, auditor’s reports, etc. List below and attach copies.

1.7 Evidence of access to financial resources to meet the qualification requirements: cash in hand, lines of credit, etc. List below and attach copies of supportive documents.

1.8 Name, address and telephone numbers of banks that may provide reference if contacted by the Employer.

1.9 Statement of compliance with the requirements of Clause 1.2 of the Instructions to Tenderers.

1.10 Proposed program (work method and schedule) for the whole of the Works.

Joint Ventures

The information listed in 1.1 – 1.10 above shall be provided for each partner of the joint venture.

In addition, the information below shall be provided for the joint venture;

1. Attach the power of attorney of the signatory(ies) of the tender authorizing signature of the tender on behalf of the joint venture
2. Attach the Agreement among all partners of the joint venture (and which is legally binding on all partners), which shows that:
 - a) all partners shall be jointly and severally liable for the execution of the Contract in accordance with the Contract terms;
 - b) one of the partners will be nominated as being in charge, authorized to incur liabilities and receive instructions for and on behalf of any and all partners of the joint venture; and
 - c) the execution of the entire Contract, including payment, shall be done exclusively with the partner in charge.

Confidential Business Questionnaire

You are requested to give the particulars indicated in part 1 and either part 2(a), 2(b), 2(c) or (2d) whichever applies to your type of business.

You are advised that it is a serious offence to give false information on this Form. (refer to clause 6.15)

Part 1 - General

Business Name:

Location of Business premises:

Country/Town.....

Postal Address:

Code: Town:

Tel No.:

E-mail: Fax:

Nature of Business:

Part 2 (a) – Individuals

Your Name in full:

Nationality: Country of Origin:

Citizenship details:

Part 2 (b) – Partnership

	Name	Nationality	Citizenship Details	Shares
1.
2.
3.

Part 2 (c) – Registered Company

Private or Public:

State the nominal and issue capital of the company.....

Nominal Kshs:

Issued Kshs:

Give details of all directors as follows:

	Name	Nationality	Citizenship Details	Shares
1.

2.
3.

Part 2 (d) – Interest in the Firm:

Are there any person/persons in (Name of Client) who has interest in this firm? Yes/No..... (Delete as necessary)

I certify that the information given above is correct.

.....

[Title]

[Signature]

[Date]

Attach proof of citizenship.

Details of Sub-Contractors

If the Tenderer wishes to sublet any portions of the Works under any heading, he must give below details of the sub-contractors he intends to employ for each portion.

Failure to comply with this requirement may invalidate the tender.

1. Portion of Works to be sublet:
 Full names of the Sub-contractor:
 Address and head office:
 Sub-contractor’s experience of similar Works carried out in the last 3 years with contract value:

2. Portion of Works to be sublet:

 Full names of the Sub-contractor:
 Address and head office:
 Sub-contractor’s experience of similar Works carried out in the last 3 years with contract value:

[Signature of Tenderer]

[Date]

Declaration

I/We have completed this form (s) accurately at the time of reply and it is agreed that all responses can be substantiated, if requested to do so, and that any inaccuracy in the information filled herein will lead to disqualification of the tenderer.

For and behalf of:

Name:

Date: Signature:

DETAILED SPECIFICATIONS

INTRODUCTION

This section specifies the general requirements for installation works, equipment and materials forming part of the Contract Works and shall apply except where specifically stated elsewhere in the Specification or on the Contract Drawings.

QUALITY OF MATERIALS

All plant, equipment and materials supplied as part of the Contract Works shall be new and of first-class commercial quality, shall be free from defects and imperfections and where indicated shall be of grades and classifications designated herein.

Materials and apparatus required for the complete installation as called for by the Specification and contract Drawings shall be supplied by the contractor unless mention is made otherwise.

Defective equipment or that damaged in the course of installation or tests shall be replaced or repaired to the approval of the Project Manager. If, in the opinion of the Engineer any equipment has deteriorated or been damaged to such an extent that it is not suitable for installation, the Contractor shall replace this equipment at his own cost.

CLEANING

Prior to installation all piping, plant and equipment shall be thoroughly cleaned.

TESTING

Manufactured Plant and Equipment Works Tests.

MECHANICAL SPECIFICATION

1. INTRODUCTION

This standard specification is intended to form part of the general specification to be included in the Standard Tender document as follows:

- I. General Conditions of contract.
- II. Preliminary clauses (supplementary to General Conditions)
- III. Technical specification(s)
- IV. Schedules of works.
- V. Appendices to specifications.

The specification comprises standard clauses, which can be used to complete specifications for Medical Gases, Air and Vacuum installations in Hospitals. The clauses are so arranged that they can be selected to suit the requirements of individual schemes and guidance notes are included to assist in the selection and completion of the clauses. All the clauses may not apply.

Dimensions and values are given in Metric S.I. units; Imperial equivalents are quoted in brackets.

Where precision in equivalent values is not important, the nearest practical or rational equivalent in Metric or Imperial units is given.

2. **REFERENCES AND STANDARDS**

STANDARDS; BRITISH STANDARDS INSTITUTION AND ISO EQUIVALENTS

BS 4-1 Structural steel sections.

BS21 Pipe Threads.

BS3643 I.S.O Metric screw Threads.

BS341 Valve Fittings for compressed Gas Cylinders.

BS1319 Medical Gas Cylinders and Anaesthetic Apparatus.

BS1172 Phosphorous Deoxidised Non-arsenical copper for General Purposes.

BS1845 Filler Metals for Brazing.

BS1723 Specification for Brazing.

BS487 Part 1: Fusion welded steel air receivers (for pressures not exceeding 500lb/sq.inch).

BS1123 Safety Valves, Gauges and fittings for air receivers and compressed air installations.

BS1780 Bourdon Tube pressure and vacuum gauges.

BS1701 Air Filters for air supply for compressors, etc.

BS 2831 Methods of air filters in filters used in air conditioning and general ventilation.

BS3928 Methods for sodium flame test for air filters.

BS4275 Selection, use and maintenance of respiratory equipment.

BS 3970 Steam sterilizers

BS3636 Methods for proving Gas Tightness of vacuum or pressurised plants.

BS1710 Identification of pipelines.

BS4099 Colours and their meanings when used for indicator lights.

CP3009 Underground piping systems.

The BS EN ISO 7396-1:2016 Medical gas pipeline systems. Pipeline systems for compressed medical gases and vacuum

ISO 21969: High-pressure flexible connections for use with medical gas systems (for manifolds)

BS EN 13348: Copper and copper alloys. Seamless, round copper tubes for medical gases or vacuum

3. **COMPLIANCE**

The Contract Works shall comply with the current editions of the following: -

- (a) The Kenya Government Regulations.
- (b) The United Kingdom Institution of Electrical Engineering Regulations for the electrical equipment of buildings.
- (c) The United Kingdom Chartered Institution of Building Services' Guides.
- (d) The Kenya Bureau of Standards Specifications.
- (e) British Standards and Codes of Practice as published by the British Standards Institution.
- (f) The County Government By-laws.
- (g) The Electrical Supply Authority By-laws.
- (h) The Kenya Building Regulations.

4. **DHSS PUBLICATIONS**

Hospital Technical Memorandum No. 02-01 Piped medical gases, medical compressed air and medical vacuum installations. Data sheet EE10.11/12 color code identification for medical gas terminal units and pipe installations.

5. **EXTENT AND DESCRIPTION OF WORKS**

V.1 Scope

The work shall include supplying, installing, testing, commissioning, demonstrating and leaving in proper working order a piped centralised supply system for medical gases comprising (oxygen) as outlined in this specification. The Contractor will also undertake training of users. The Contractor shall comply in all respects with the specifications, but the Contractor may offer alternatives provided that the differences and advantages are clearly detailed by him on the schedule of alternatives to be attached and returned with the tender. The awarded Contractor will be required to comply to OSHA requirements during installation works and to provide risk assessment and safety methods statements prior to commencing the works.

V.2 As-Installed Drawings

During the course of construction, the contractor shall correct one copy of the contract drawings daily as the work proceeds, indicating any change made from the arrangement shown in the contract drawings.

This amended drawing shall remain on site, readily available for inspection, and the amendments must ultimately be transferred to a reproducible copy of the contract drawing.

V.3 Manifold

V.3.1 Automatic manifold assembly

The manifolds for all the specified gases (and air) shall be as far as possible identical in construction and the following clauses refer to the assemblies any of the “gases”.

V.3.2 Manifold Headers

Each bank of cylinders shall be located beneath a high-pressure manifold header securely mounted control panel. The headers shall carry flexible spiral tail pipes on the underside for connecting to the cylinders and each tail pipe shall incorporate a renewable non-return valve on the manifold header to allow removal and replacement of the cylinder without interrupting the supply from others in the same bank.

V.3.3 Non-interchangeability of cylinder connections

The screwed connections of the tail pipes to the cylinder valves shall be designed such that cross connection of the pipe for any one gas cannot be made to any cylinders for the gases, the exception being oxygen and air which to BS. 341 part 1 are identical.

V.3.4 Testing of Headers.

The manifold and tail pipe assembly shall be capable of withstanding a working gauge pressure of minimum 200 bar and shall be tested to twice this pressure by the manufacturer at his work and a test certificate supplied.

V.3.5 De-Greasing.

The assembly shall be de-greased and delivered to site in a sealed polythene bag or cover and labelled to the effect that it is de-greased and shall on no account be contaminated by dirt oil or grease during erection of afterwards.

V.3.6 Manifold Control Panel

Each pair of headers shall connect to a control panel which shall automatically reduce the high pressure gas or air to a low distribution gauge pressure of 4.14 bar+ 0.14 bar (60 p.s.i.+ 2 p.s.i) for gases or 7.3 bar + 0.15 bar (105 p.s.i. + 2.5 p.s.i) for air.

V.3.7 Control Panel Identification

Each panel shall carry in large letters on the front the name of the gas being controlled the letters shall be embossed engraved or otherwise marked on so as to be indelible.

Painting or adhesive lettering shall not be permitted.

V.3.8 Automatic Operation

The control panel shall dispense gas (or air) from each of the two-cylinder banks in turn via a common distribution pipe and when the “duty” bank pressure falls to 7 bar g. (100 p.s.i.) on “gas” manifolds or 10 bar g. (145 p.s.i.) on air manifolds, the panel shall automatically switch over to the “reserve” bank without any interruption of the supply.

The panel shall incorporate a pressure regulator, a pressure switch and automatic valve to each bank in order to carry out the above operations. It shall be possible to select either bank of cylinders as the duty bank and to change over manually to the reserve bank despite any electrical supply failure.

A reserve pressure regulator to each bank shall automatically take over if the changeover valve fails to operate or if the low-pressure regulator fails to open sufficiently. It shall be possible to carry out maintenance work on the pressure regulators and parts for one bank without affecting the supply from the other bank.

Automatic panel shall be capable of passing 300 litres per minute at a gauge pressure of 4.14 bar (60 P.S.I.) for “gases” and 7.3 bar (105 P.S.I) for air.

V.3.9 Pressure Gauges

The control panel shall incorporate three pressure gauges: one high pressure gauge to each cylinder bank and one common low-pressure gauge on the outgoing supply to the distribution pipework. The gauges shall conform to BS.1780 and be graduated in bars and p.s.i. gauge shall carry the name of the gas on the dial face with warning- “USE NO OIL OR GREASE” Gauge shall be degreased and maintained in this condition before and after installation.

The dials shall be marked with a blue line at the normal working pressure and a red line at the minimum allowable.

V.3.10 Electricity supply

The manifolds shall be suitable for operating from 240 volts, single phase/3 phase and neutral 50 A.C. supply. Any internal wiring in the panel shall have a flame- retardant sheathe to comply with I.E.E regulation B.16.

The contractor to connect the manifold panel to the existing electrical power outlet.

V.4 Valves

V.4.1 Main Stop Valve.

A main stop valve shall be fitted on the distribution main before the service point is reached in order to allow the control panel to be isolated. The valve shall be in a readily accessible position in the manifold room so that it can also serve as an emergency valve. It need not be housed in a valve box.

V.4.2 Safety Relief Valve

A self – closing safety relief valve shall be fitted on the distribution pipe in between the control panel and the main stop valve. The valve shall have a flow capacity head equal to the maximum flow rate of the control panel.

All pressure-relief valves shall close automatically when excess pressure has been released

All safety valves should conform to BS EN ISO 4126-1:2004.

Tests of Pressure relief valves: The performance of pressure-relief valves shall be in accordance with ISO 7396:2007 section 7.2.5 and 7.2.6 and shall comply with 5.2.6. Bursting discs shall not be used for this purpose.

Safety valves will be set to operate at a maximum 1.5 times the nominal pressure.

Line pressure shall be continuously monitored by an electronic pressure sensor, where the alarm settings are adjustable and shall be set to operate at +/- 20% of the nominal pressure, when the pressure in the pipeline is above or below the set limits and operate the Automatic Manifold panel to changeover, while displaying the low or high alarms in the display panel according to ISO 7396-01:2016 requirements of section 3.5 and 5.2.6, which are audiovisual type.

The valve shall be of a type which can be locked or sealed and shall be non-ferrous material. It shall be coupled to a copper vent pipe one size larger than the distribution pipe and vented to atmosphere at a suitable level and position outside the building. The end of the vent pipe shall terminate in an inverted "U" bend with wire mesh and a suitable shield to protect against snow and ice.

The discharge point shall be finally agreed on site by the Project Manager and Contractor to ensure that there is no danger of fire, injury to personnel, contamination or interference with air intakes or windows. The safety valve and vent pipe shall be supplied and installed in a degressed condition.

Weatherproof notices shall be fixed at each discharge point stating: - **DANGER KEEP CLEAR. MEDICAL GAS DISCHARGE POINT.**

V.5 Medical Gas alarms

Medical gas zone and alarm valves conforming to ISO 7396-1.

6. DISTRIBUTION PIPEWORK SYSTEM

6.1 Extent of Pipework

The Contractor shall supply, install, connect up and test all the pipework and valves required from the supply source to the distribution terminals for oxygen. The pipe sizes and valve positions shall be as given in Bills of Quantities and test procedure as described later.

6.2 Fixing

All pipework shall be fixed without any springing or forcing. A clearance of 150mm (6") shall be maintained between the pipework and other services. Where pipework crosses other services a clearance of 25mm (1") minimum shall be maintained.

6.3 Drainage

A full way drain lock is to be provided at the bottom of each main vertical run on the oxygen pipework. Branches on horizontal air pipe work shall be taken from the topside of mains to avoid pockets of moisture. This shall be put to use in circumstances where the contractor is joining 2 separate buildings and shall use PPR to conduit the cleanout as it goes underground. The drainage will assist in draining the water residue and avoid clogging the corner joineries.

6.4 Routing to avoid Fire Risk Area

The routes of the pipework shall avoid fire risk areas including laundries boiler houses, generator rooms, incinerator rooms, storage rooms for combustible materials (unless the pipes are to be cased), lift shafts and kitchens.

6.5 Pipework Supports

Pipework shall be supported at not greater than the intervals shown in the table below:
Nominal Pipe outside diameter mm BS EN 1057

Part 1: Maximum Intervals

For Dia(mm)	For Vertical Runs (Meters)	For Horizontal Runs (Meters)
12	1.2	1
15	1.8	1.2
18	2	1.5
22	2.4	1.8
28	2.4	1.8

Where valves are fitted the pipe shall be supported at both sides of the valve to facilitate valve operation without valve movement. Fixing brackets or supports shall be of a suitable non-ferrous material or suitability treated to minimize corrosion and prevent electronic action.

The Contractor shall drill and plug walls and ceilings as required fastening the supports. Where roof decking is encountered the Contractor shall provide cavity fixing devices to fasten the supports.

6.6 Pipework in Floors, Walls, Ceilings

Pipework in rooms and corridors shall be concealed either behind ceiling panels, or in walls, ducts or trucking. Removable covers or panels shall be provided to allow access to pipework. Pipework shall not be buried solidly in floors, walls or ceiling except with the approval of the Project Manager. Approval will normally be given only for tail pipes in one piece from Terminal unit to service duct or ceiling void and for unjointed pipes from control valve to void.

The route of the buried pipe should be clearly and continuously marked by chalk, coloured adhesive tape or otherwise, during construction, to discourage the driving of nails into or near the pipe. Where pipes are to be installed in partition walls the tail pipes of terminal unit shall be in one piece (without joint) form the terminal unit to the service doctor ceiling void. Service ducts or voids should have adequate ventilation to prevent gas concentration in the event of a leak.

Where pipes pass through floors, walls or partitions, copper sleeves shall project between 1.5 and 3mm (1/16” and 1/18”) beyond finished surfaces and plates shall be fitted. All joints shall be accessible, and no joint shall be made so that it’s inside the pipe sleeve. Where pipework is to be concealed it shall not be covered over until it has satisfactory passed all pressure tests. Pipework in service ducts, or voids or in rooms or in corridors where the pipework is not required to be concealed shall be surface run.

6.7 Special Precautions against Corrosion.

Where pipework is supported by or is liable to come into contact with timber that has been treated with compounds likely to cause corrosion of copper, the pipe shall be protected locally by impermeable materials such as p.v.c. tape or spacers.

6.8 Mounting Height

The mounting height of the terminal units above floor level shall be as follows: -

- a) Flush Mounted Units - 1.3m (4’ - 4”) to centre of Unit
- b) Raised Surface Mounted Units - 1.6m (5’ - 2”) to centre of unit
- c) “Rail” Systems areas - 1.5m (5’-0”) to centre of unit.

6.9 Exact Positioning of Terminal Unit.

The exact position of the terminal units relative to the beds, operating tables, etc. shall be finally agreed between the facility Biomedical Engineer and the Contractor.

6.10 Purging and Pressure/leakage testing

All pipework installation shall be pressure tested in accordance with the requirements of the various sections of this Specification laid out in ISO 7396-1. The installation may be tested in sections to suit the progress of the works, but all tests must be carried out before the work is buried or concealed behind building finishes. All tests must be witnessed by the Project Manager or his representative, and the Contractor shall give 7 days’ notice to the Project Manager of his intention to carry out such tests. The pressure testing will be signed off by the Facility In-charge, Client’s Designated Biomedical Engineer and the Project Manager assigned Biomedical engineering consultant.

The Contractor shall prepare test certificates for signature by the Project Manager and shall keep a progressive and up-to-date record of the sections of the work that have been tested.

Copies of all test and inspection certificates and performance graphs, test results and standing test pressure (suction pressure option), shall be submitted to the Project Manager for his approval as soon as possible after the completion of such tests and inspections.

All pipework shall be purged using inert gases such as Nitrogen and also use of medical gases designated for the pipeline is acceptable. All tests must be witnessed by the Project Manager or his representative, and the Contractor shall give 7 days’ notice to the Project Manager of his intention to carry out such tests.

Examples of compulsory tests are as tabulated below;

Tests	Procedures
Blowdown	Lines are blown clear using oil-free dry nitrogen
Initial pressure test	System is subjected to 1.5 times working pressure to check leaks
Standing pressure test	System is subjected to 29% higher pressure for 24hr
Piping purge	Purging of each outlet until there is no discoloration of the white cloth held over it
Cross-connection test	One gas system at a time using oxygen analyzer
Final tie-in test	Active vacuum pipeline joints are tested using as ultrasonic leak detector

6.11 Colour coding

Unless stated otherwise in the Particular Specification all pipework shall be colour coded in Accordance with the latest edition of B.S. (ISO) 1710

PART B: FINANCIAL
(BILLS OF QUANTITIES)

(It should be noted that the information provided in this BOQ regarding pipe lengths, diameters, number of fittings and other specific details should be considered as approximate and indicative only. Amref shall maintain responsibility for primary definition of the scope, such as the governing standards for design, the number and location of patient beds served and total number of outlets in each ward, whereas the final design and specific details and quantities of the BOQ shall be the responsibility of the bidding contractor. The bidding contractor shall be ultimately responsible for their own design and engineering to determine pipe sizes, number of joints, efficient routing, required fittings etc. that are included in their bid and proposed scope of works.)

No	Description	Qty	Unit	Rate	Amount (KShs)
<u>BILL 1 - PIPING WORKS</u>					
A	Distribution systems				
1.0	Manifold : Fully automatic Medical Oxygen Gas Manifold manufactured to ISO7396-1:2016 standards, complete with two stage regulator, monitoring alarm and hose connection ports with valves, with corresponding cylinders holding racks.				
	1(a) Wall mounted manifold (10x2)	0	No		
	1(b) Wall mounted manifold (8x2)	1	No		
	1(c) Wall mounted manifold (5x2)	0	No		
2.0	Cylinder connection steel braided pig tail hoses, Corresponding to item 1a or 1b or 1c above	16	No		
B	Copper pipes and fittings: Degreased copper pipes, manufactured from phosphorus de-oxidized non- arsenical copper to conform to ISO7396-1:2016 or BS EN13348:2016				
1.0	Pipes:				
	22mm diameter degreased copper pipes in metres	50	LM		
	15mm diameter degreased copper pipes in metres	81	LM		
	12mm diameter degreased copper pipes in metres	24	LM		
2.0	Elbows:				
	22mm diameter degreased copper elbows	5	Pcs		
	15mm diameter degreased copper elbows	21	Pcs		
3.0	Couplers:				
	22mm diameter degreased copper straight couplers	25	Pcs		
	15mm diameter degreased copper straight couplers	41	Pcs		
4.0	Reducers:				
	22x15mm diameter degreased copper reducer	10	Pcs		
	15x12mm diameter degreased copper reducer	16	Pcs		
5.0	Tees:				
	22mm diameter degreased copper equal Tees	10	Pcs		
	15mm diameter degreased copper equal Tees	16	Pcs		
C	Line ball valves c/w NIST,				
1.0	22mm medical gas line valves	1	Item		
2.0	15mm medical gas line valves	2	Item		
3.0	AVSU - 15mm oxygen area valve service unit complete with gauges	0	Item		
Total carried to collection on page 2					

MFL:14663 HF: Aic Kalokol Health Centre

No	Description	Qty	Unit	Rate	Amount (KShs)
D	Medical Oxygen gas alarms				
1.0	Medical gas (oxygen only) monitoring alarm with % purity and pressure, with audio and visual display panels, conforming to ISO7396-1:2016	1	No		
E	Distribution Accessories				
1.0	22mm musen rings complete	5	No		
2.0	22mm plastic wall clamp	25	No		
3.0	15mm plastic wall clamp	41	No		
4.0	12mm plastic wall clamp	16	No		
5.0	M10 threaded rod	0	LM		
6.0	M10 hungers	0	No		
F	Oxygen terminal outlets, wall mount as per specifications IN THIS DOCUMENT	16	No		
G	1) Trunking for contingencies.	5	LM		
	2) Conduits for contingencies.	0	LM		
H	Provisional Sums - 50,000				
1.0	Allow for permanent and temporary identification of pipelines, valves.		Item		
2.0	PURGING: Allow for flushing the whole system with medical gases in accordance with ISO7396-1:2016 and to the satisfaction of the project Engineers. Purging is to be done using an inert gas such as Nitrogen.		Item		
3.0	TESTING AND COMMISSIONING: Allow for testing and commissioning of the entire medical gas pipeline system (using an inert gas such as Nitrogen), in accordance with the particular specification and to the satisfaction of the project Engineer, based on the (ISO7396-1:2016). The test such as pressure, leakage results duly recorded and clearly qualified in the commissioning report.		Item		
I	LABOUR COST		Item		
	Total carried to collection below				
	Collection:				
1.0	Total brought forward from page 1				
2.0	Total brought down from above				
	Total for Bill 1 - PIPING WORKS carried to Facility Summary on Page 14				

No	Description	Qty	Unit	Rate	Amount (KShs)
<u>BILL 2 - MANIFOLD SHED</u>					
ELEMENT No.1: SUBSTRUCTURES					
(ALL PROVISIONAL)					
EXCAVATION & FILLING					
Excavation					
A	Excavate 300mm deep to remove vegetable soil, load, wheel and deposit on site where directed.	24	SM		
B	Excavate to reduced levels 300mm (deep)	8	CM		
C	Excavate 60mm wide trench commencing from stripped level and not exceeding 600mm from reduced level	6	CM		
Plunking and Strutting					
D	Plunking and Strutting to sides of all excavations including keeping excavations free from all fallen materials	1	ITEM		
Disposal of water					
E	Allow for keeping excavations free from water all over	1	ITEM		
Fillings					
F	Return fill and compact selected excavated earthfilling in foundation to make up levels	3	CM		
Approved Murram/Red Soil Filling					
G	300mm thick approved murrum or red soil back filling; well rolled and compacted in 2 layers not exceeding 150mm deep to 96% compaction at optimum moisture content to bring up levels.	3	CM		
Approved Imported Filling					
H	300mm thick approved imported hardcore filling; well rolled and compacted in 2 layers not exceeding 150mm deep to 96% compaction at optimum moisture content	3	CM		
J	50mm thick quality murrum blinding on surfaces of hardcore	9	SM		
Disposal of Surplus Spoil:-					
K	Load and cart away surplus spoil from the site and deposit the same away from site where directed to approved dumping site	3	CM		
Total carried to collection on page 5					-

No	Description	Qty	Unit	Rate	Amount (KShs)
A	Anti-Termite Treatment Chemical anti-termite treatment to subsoil or filling: RENTOKIL. or equal approved: provide a ten year guarantee	9	SM		
B	Damp Proof Membrane 1000g Polythene damp proof membrane laid under floor bed with 300mm side and end lap (measured nett allow for laps)	13	SM		
SUBSTRUCTURE CONCRETE WORKS					
<u>Plain concrete class 15 (mix 1:3:6) as described, in:-</u>					
C	50mm thick surface blinding under strip footing and column bases	10	SM		
<u>In situ concrete class 25/20 , vibrated and reinforced as described, in:-</u>					
D	150mm thick strip footing	2	CM		
E	150mm thick floor slab	13	SM		
Reinforcement <u>High tensile steel reinforcement to B.S. 4449:2005 in structural concrete work including cutting, bending, hoisting, fixing, tying wire and spacing blocks in strip Footing</u>					
F	T10 (main bars)	30	KG		
G	T8 (binders)	20	KG		
<u>Mesh fabric reinforcement to B.S. 4483 and setting in concrete with 300mm side and end laps (measured nett-allow for laps)</u>					
H	Fabric mesh ref: A65 in floor bed	13	SM		
<u>Sawn formwork to:-</u>					
J	Ditto egdes of slabs, girth 75mm-150mm high	17	LM		
Masonry Works -Substructures <u>Load bearing natural stone walling, jointed in cement and sand (1:4) mortar with and including No. 20 gauge hoop iron ties 450mm long x 25mm wide bent and tacked into formwork with one end cast into concrete and straightened after removal of formwork and built into mortar joint of walling.</u>					
K	200mm thick wall in foundations	17	SM		
Total carried to collection on page 5					

No	Description	Qty	Unit	Rate	Amount (KShs)
	Plinth Finishing				
A	15mm thick cement, sand (1:4) render to plinth	5	SM		
B	Prepare and apply two undercoats and one finishing coat of first grade bituminous paint or equal approved on rendered plinth	5	SM		
	Total carried down to collection below				
	<p><u>Collection</u></p> <p>Brought forward from page 3</p> <p>Brought forward from page 4</p> <p>Brought down from above</p>				
	Total for SUBSTRUCTURES carried to summary on page 12				

No	Description	Qty	Unit	Rate	Amount (KShs)
	ELEMENT No.2: SUPERSTRUCTURES				
A	Damp Proof Course 200mm wide bituminous felt as damp proof course and including 200mm laps	7.2	LM		
	Masonry Works -Superstructures Machine cut natural stone / concrete block wall; load bearing 7.0 N/mm ² ; bedded and jointed in cement and sand (1:4) mortar reinforced with 25mm x 20mm gauge hoop iron at every alternate course as described in;				
B	200mm thick walling	18	SM		
	Concrete Beam Insitu concrete class 25/20 , vibrated and reinforced as described, in	2	CM		
C	200 x200mm beam				
	High tensile steel reinforcement to B.S. 4449:2005 in structural concrete work including cutting, bending, hoisting, fixing, tying wire and spacing blocks in beam				
D	T10 (main bars - 4No)	18	KG		
	T8 (binders @200c/c)	10	KG		
	Pallisade walling <u>Mild steel pallisade walling in:-</u>				
E	40 x 40 x 1.2mm thick SHS vertical members securely fixed to ground slab at every coner and ends welding to roof rails (floor and roof height 2400mm) 6No.	15	LM		
F	40 x 40 x 1.2mm thick SHS horizontal members fixed to same size vertical member (m.s) by welding in 3 rows (top centre and bolttom as per the design	38	LM		
G	2100mm long 25 x 25 x 1.2mm thick SHS, vertical members fixed at 150 centre to centre including assembly and welding to horizontal members (ms) with an offset of 75mm from finished floor level	164	LM		
	Rain water goods				
H	Supply 140 mm U-shaped plastic gutters including necessary accessories such as brackets, end caps, and downspouts, and fix using appropriate fasteners.	7	LM		
J	75mm dia PVC downpipes	5	LM		
K	Ditto but 45° bend	4	No		
	Total carried to collection on page 7				

No	Description	Qty	Unit	Rate	Amount (KShs)
	Steel Door				
	<u>Fabricated to same matching design to pallisade walling:</u>				
A	2000mm wide double leaf steel door fabricated in 40x40x1.2mm thick SHS leaf vertical edge members (2100mm high) and 3 rows horizontal members and 25x25x1.2mm SHS 2100mm high vertical members at 150mm centre to centre synchronising in pattern to the pallisade wall and to the engineers details and including locking latch suitable for padlocking.	1	No		
	Framed Steel Roof Structure				
	Hollow section steel of various sizes cut to size with welded and/or bolted connections including hoisting and fixing and primed in grey oxide;				
B	40 x 40 x 1.2mm SHS rafters	12	LM		
C	Ditto beam over vertical members to support the roof	9	LM		
D	Ditto struts and ties	3	LM		
E	Ditto purlins	21	LM		
	Roof Covering				
F	28 Gauge box profile pre-painted sheet in roof covering 100 mm lap and 75 mm side laps screwed to purlins using self-drilling screws with rubber caps	21	SM		
G	28 gauge pre-painted ridge cap	7	LM		
	Painting Works				
	Prepare surfaces and apply one coat of approved primer and two finishing coats oil based/gloss paint to general surface of metal				
H	Roof and wall steel members not exceeding 50mm girth	342	LM		
	Concrete Ramp				
J	Allow for 2000mm wide concrete ramp at the entrance at a 10 degrees slope	1	ITEM		
	Total carried down to collection below				
	Collection:				
	Total brought forward from page 6				
	Total brought down from above				
	Total for SUPERSTRUCTURES carried to summary on page 12				

No	Description	Qty	Unit	Rate	Amount (KShs)
	ELEMENT No.3: FINISHES				
	WALL FINISHES				
	19mm thick cement and sand (1:4) gauged plaster on stone wall steel trowelled to:-				
A	Walls internally	20	SM		
B	Beam and walls above the beam externally	2	SM		
	Prepare and apply two undercoats and one finishing coat of plastic vinyl emulsion paint to:-				
C	Plastered walls internally and externally	22	SM		
	FLOOR FINISH:				
D	25mm thick cement screed to receive terrazzo finish	13	SM		
E	Terrazzo floor finish on screeded floor	13	SM		
	Total for FINISHES carried to summary on page 12				

No	Description	Qty	Unit	Rate	Amount (KShs)
	<p>ELEMENT No.4: ELECTRICAL INSTALLATION WORKS</p> <p>Note: The work under this element is to be carried out by a registered electrical subcontractor subject to the approval</p> <p>Supply, install test and commission in accordance to BS 7671:1998, the following as described below:</p> <p>LIGHTING INSTALLATION</p> <p>Lighting points wired in 3 x 1.5 sq.mm PVC insulated single core copper cable drawn in 20mm dia. PVC Heavy gauge conduit concealed in walls, for two way switching, where the total distance to between light and switch is 5 metres</p> <p>10A 240V wall mounted switch plates as legrand or equal and approved as described</p> <p>One gang one way</p> <p>Supply and install the following lighting fixtures complete with the control switchgears and lamp as per description and symbols:</p> <p>1x 2ft LED fluorescent fittings surface mounted as Power Technics Manufacture or equal and approved type 48</p> <p>SMALL POWER INSTALLATION</p> <p>Ring mains circuit power points wired in 3 x 2.5 sq.mm PVC insulated single core copper cable draw 20 mm heavy gauge conduits concealed in walls, total distance between the sockets is 10 metres</p> <p>240V white moulded socket plates as Legrand or equal and approved as described</p> <p>13A twin standard socket</p> <p>POWER DISTRIBUTION AND SUBMAINS INSTALLATION</p> <p>4 Ways 63A DP flush mounted consumer unit CCU</p> <p>MCBs for the items above</p> <p>10A SP for lighting</p> <p>30A SP for sockets</p>				
A	Lighting points wired in 3 x 1.5 sq.mm PVC insulated single core copper cable drawn in 20mm dia. PVC Heavy gauge conduit concealed in walls, for two way switching, where the total distance to between light and switch is 5 metres	1	NO		
B	10A 240V wall mounted switch plates as legrand or equal and approved as described One gang one way	1	No		
C	Supply and install the following lighting fixtures complete with the control switchgears and lamp as per description and symbols: 1x 2ft LED fluorescent fittings surface mounted as Power Technics Manufacture or equal and approved type 48	1	No		
D	Ring mains circuit power points wired in 3 x 2.5 sq.mm PVC insulated single core copper cable draw 20 mm heavy gauge conduits concealed in walls, total distance between the sockets is 10 metres	1	No		
E	240V white moulded socket plates as Legrand or equal and approved as described	1	No		
F	13A twin standard socket	1	No		
G	4 Ways 63A DP flush mounted consumer unit CCU	1	No		
A	MCBs for the items above 10A SP for lighting	1	No		
B	30A SP for sockets	1	No		
	Total carried to collection on page 10				

No	Description	Qty	Unit	Rate	Amount (KShs)
C	Blanking plates	2	No		
D	Provide material for cabling to consumer units from hospital DB 2.5mm sqd TWE in 20 mm h/g conduits running on the surface with saddle clips	50	LM		
E	Saddle clips 20 mm	20	Pcs		
Total carried down to collection below					
<p>Collection:</p> <p>Total brought forward from page 9</p> <p>Total brought down from above</p>					
Total for ELECTRICAL INSTALATION WORKS carried to summary on page 12					

No	Description	Qty	Unit	Rate	Amount (KShs)
A	<p>ELEMENT NO.5: PROVISIONAL SUMS</p> <p>Allow a Provisional sum of Kenya Twent Five Thousand (Kshs. 25,000/=) only for Contigencies</p>	1	ITEM		
	<p>Total for PROVISIONAL SUMS carried to summary on page 12</p>				

Summary Page

No	Description	Amount (KShs)
5	Total for SUBSTRUCURES brought forward from page 5	
5	Total for SUPERSTRUCTURES brought forward from page 7	
5	Total for FINISHES brought forward from page 8	
5	Total for ELECTRICAL INSTALLATION WORKS brought forward from page 10	
5	Total for PROVISIONAL SUMS brought forward from page 11	
	Total for Bill 2 - MANIFOLD SHED carried to Facility Summary on Page 14	

No	Description	Qty	Unit	Rate	Amount (KShs)
<u>BILL 3 - CYLINDER RACK</u>					
DETAILS AND DESCRIPTION - REFER TO THE DRAWING FOR MORE CLARIFICATIONS.					
1	RHS - 2X2 INCHES, 2 MM THICKNESS	30	LM		
2	DRILLING - DRILL MOUNTING HOLES AS PER THE DRAWING	12	No.		
3	FLAT BAR - 1-1/2" X1/4"	6	LM		
4	CHAIN - GRADE 30	8	LM		
5	RAWLBOLT - M-10	10	PCS		
6	PAINTWORKS - 2 COATS SPRAY PAINTING, BLACK COLOUR	1	LTRS		
7	TOP CAPS - HDPE TO COVER 2" SQUARE HOLLOW AS	12	PCS		
8	LABOUR - CONTINUOUS WELDING, MOUNTING		Item		
Total for Bill 3 - CYLINDER RACK carried to Facility Summary on Page 14					

FACILITY SUMMARY PAGE

No	Description	Quoted Amount	Required No.	Amount (KShs)
5	Total for Bill 1 - PIPING WORKS brought forward from page 2		1	
5	Total for Bill 2 - MANIFOLD SHED brought forward from page 12		1	
5	Total for Bill 3 - CYLINDER RACK brought forward from page 13		1	
Total for Health Facility carried to LOT SUMMARY Page				

No	Description	Qty	Unit	Rate	Amount (KShs)
<u>BILL 1 - PIPING WORKS</u>					
A	Distribution systems				
1.0	Manifold : Fully automatic Medical Oxygen Gas Manifold manufactured to ISO7396-1:2016 standards, complete with two stage regulator, monitoring alarm and hose connection ports with valves, with corresponding cylinders holding racks.				
	1(a) Wall mounted manifold (10x2)	0	No		
	1(b) Wall mounted manifold (8x2)	1	No		
	1(c) Wall mounted manifold (5x2)	0	No		
2.0	Cylinder connection steel braided pig tail hoses, Corresponding to item 1a or 1b or 1c above	16	No		
B	Copper pipes and fittings: Degreased copper pipes, manufactured from phosphorus de-oxidized non- arsenical copper to conform to ISO7396-1:2016 or BS EN13348:2016				
1.0	Pipes:				
	22mm diameter degreased copper pipes in metres	61	LM		
	15mm diameter degreased copper pipes in metres	28	LM		
	12mm diameter degreased copper pipes in metres	17	LM		
2.0	Elbows:				
	22mm diameter degreased copper elbows	7	Pcs		
	15mm diameter degreased copper elbows	7	Pcs		
3.0	Couplers:				
	22mm diameter degreased copper straight couplers	31	Pcs		
	15mm diameter degreased copper straight couplers	14	Pcs		
4.0	Reducers:				
	22x15mm diameter degreased copper reducer	10	Pcs		
	15x12mm diameter degreased copper reducer	11	Pcs		
5.0	Tees:				
	22mm diameter degreased copper equal Tees	10	Pcs		
	15mm diameter degreased copper equal Tees	11	Pcs		
C	Line ball valves c/w NIST,				
1.0	22mm medical gas line valves	1	Item		
2.0	15mm medical gas line valves	1	Item		
3.0	AVSU - 15mm oxygen area valve service unit complete with gauges	0	Item		
Total carried to collection on page 2					

MFL:14387 HF: Chesta dispensary

No	Description	Qty	Unit	Rate	Amount (KShs)
D	Medical Oxygen gas alarms				
1.0	Medical gas (oxygen only) monitoring alarm with % purity and pressure, with audio and visual display panels, conforming to ISO7396-1:2016	1	No		
E	Distribution Accessories				
1.0	22mm musen rings complete	7	No		
2.0	22mm plastic wall clamp	31	No		
3.0	15mm plastic wall clamp	14	No		
4.0	12mm plastic wall clamp	11	No		
5.0	M10 threaded rod	0	LM		
6.0	M10 hungers	0	No		
F	Oxygen terminal outlets, wall mount as per specifications IN THIS DOCUMENT	11	No		
G	1) Trunking for contingencies.	0	LM		
	2) Conduits for contingencies.	10	LM		
H	Provisional Sums - 50,000				
1.0	Allow for permanent and temporary identification of pipelines, valves.		Item		
2.0	PURGING: Allow for flushing the whole system with medical gases in accordance with ISO7396-1:2016 and to the satisfaction of the project Engineers. Purging is to be done using an inert gas such as Nitrogen.		Item		
3.0	TESTING AND COMMISSIONING: Allow for testing and commissioning of the entire medical gas pipeline system (using an inert gas such as Nitrogen), in accordance with the particular specification and to the satisfaction of the project Engineer, based on the (ISO7396-1:2016). The test such as pressure, leakage results duly recorded and clearly qualified in the commissioning report.		Item		
I	LABOUR COST		Item		
	Total carried to collection below				
	Collection:				
1.0	Total brought forward from page 1				
2.0	Total brought down from above				
	Total for Bill 1 - PIPING WORKS carried to Facility Summary on Page 14				

No	Description	Qty	Unit	Rate	Amount (KShs)
<u>BILL 2 - MANIFOLD SHED</u>					
ELEMENT No.1: SUBSTRUCTURES					
(ALL PROVISIONAL)					
EXCAVATION & FILLING					
Excavation					
A	Excavate 300mm deep to remove vegetable soil, load, wheel and deposit on site where directed.	24	SM		
B	Excavate to reduced levels 300mm (deep)	8	CM		
C	Excavate 60mm wide trench commencing from stripped level and not exceeding 600mm from reduced level	6	CM		
Plunking and Strutting					
D	Plunking and Strutting to sides of all excavations including keeping excavations free from all fallen materials	1	ITEM		
Disposal of water					
E	Allow for keeping excavations free from water all over	1	ITEM		
Fillings					
F	Return fill and compact selected excavated earthfilling in foundation to make up levels	3	CM		
Approved Murram/Red Soil Filling					
G	300mm thick approved murrum or red soil back filling; well rolled and compacted in 2 layers not exceeding 150mm deep to 96% compaction at optimum moisture content to bring up levels.	3	CM		
Approved Imported Filling					
H	300mm thick approved imported hardcore filling; well rolled and compacted in 2 layers not exceeding 150mm deep to 96% compaction at optimum moisture content	3	CM		
J	50mm thick quality murrum blinding on surfaces of hardcore	9	SM		
Disposal of Surplus Spoil:-					
K	Load and cart away surplus spoil from the site and deposit the same away from site where directed to approved dumping site	3	CM		
Total carried to collection on page 5					-

No	Description	Qty	Unit	Rate	Amount (KShs)
A	Anti-Termite Treatment Chemical anti-termite treatment to subsoil or filling: RENTOKIL. or equal approved: provide a ten year guarantee	9	SM		
B	Damp Proof Membrane 1000g Polythene damp proof membrane laid under floor bed with 300mm side and end lap (measured nett allow for laps)	13	SM		
SUBSTRUCTURE CONCRETE WORKS					
<u>Plain concrete class 15 (mix 1:3:6) as described, in:-</u>					
C	50mm thick surface blinding under strip footing and column bases	10	SM		
<u>In situ concrete class 25/20 , vibrated and reinforced as described, in:-</u>					
D	150mm thick strip footing	2	CM		
E	150mm thick floor slab	13	SM		
Reinforcement <u>High tensile steel reinforcement to B.S. 4449:2005 in structural concrete work including cutting, bending, hoisting, fixing, tying wire and spacing blocks in strip Footing</u>					
F	T10 (main bars)	30	KG		
G	T8 (binders)	20	KG		
<u>Mesh fabric reinforcement to B.S. 4483 and setting in concrete with 300mm side and end laps (measured nett-allow for laps)</u>					
H	Fabric mesh ref: A65 in floor bed	13	SM		
<u>Sawn formwork to:-</u>					
J	Ditto egdes of slabs, girth 75mm-150mm high	17	LM		
Masonry Works -Substructures <u>Load bearing natural stone walling, jointed in cement and sand (1:4) mortar with and including No. 20 gauge hoop iron ties 450mm long x 25mm wide bent and tacked into formwork with one end cast into concrete and straightened after removal of formwork and built into mortar joint of walling.</u>					
K	200mm thick wall in foundations	17	SM		
Total carried to collection on page 5					

No	Description	Qty	Unit	Rate	Amount (KShs)
	Plinth Finishing				
A	15mm thick cement, sand (1:4) render to plinth	5	SM		
B	Prepare and apply two undercoats and one finishing coat of first grade bituminous paint or equal approved on rendered plinth	5	SM		
Total carried down to collection below					
	<u>Collection</u>				
	Brought forward from page 3				
	Brought forward from page 4				
	Brought down from above				
Total for SUBSTRUCTURES carried to summary on page 12					

No	Description	Qty	Unit	Rate	Amount (KShs)
	ELEMENT No.2: SUPERSTRUCTURES				
A	Damp Proof Course 200mm wide bituminous felt as damp proof course and including 200mm laps	7.2	LM		
	Masonry Works -Superstructures Machine cut natural stone / concrete block wall; load bearing 7.0 N/mm ² ; bedded and jointed in cement and sand (1:4) mortar reinforced with 25mm x 20mm gauge hoop iron at every alternate course as described in;				
B	200mm thick walling	18	SM		
	Concrete Beam Insitu concrete class 25/20 , vibrated and reinforced as described, in	2	CM		
C	200 x200mm beam				
	High tensile steel reinforcement to B.S. 4449:2005 in structural concrete work including cutting, bending, hoisting, fixing, tying wire and spacing blocks in beam				
D	T10 (main bars - 4No)	18	KG		
	T8 (binders @200c/c)	10	KG		
	Pallisade walling <u>Mild steel pallisade walling in:-</u>				
E	40 x 40 x 1.2mm thick SHS vertical members securely fixed to ground slab at every coner and ends welding to roof rails (floor and roof height 2400mm) 6No.	15	LM		
F	40 x 40 x 1.2mm thick SHS horizontal members fixed to same size vertical member (m.s) by welding in 3 rows (top centre and bolttom as per the design	38	LM		
G	2100mm long 25 x 25 x 1.2mm thick SHS, vertical members fixed at 150 centre to centre including assembly and welding to horizontal members (ms) with an offset of 75mm from finished floor level	164	LM		
	Rain water goods				
H	Supply 140 mm U-shaped plastic gutters including necessary accessories such as brackets, end caps, and downspouts, and fix using appropriate fasteners.	7	LM		
J	75mm dia PVC downpipes	5	LM		
K	Ditto but 45° bend	4	No		
	Total carried to collection on page 7				

No	Description	Qty	Unit	Rate	Amount (KShs)
	Steel Door				
	<u>Fabricated to same matching design to pallisade walling:</u>				
A	2000mm wide double leaf steel door fabricated in 40x40x1.2mm thick SHS leaf vertical edge members (2100mm high) and 3 rows horizontal members and 25x25x1.2mm SHS 2100mm high vertical members at 150mm centre to centre synchronising in pattern to the pallisade wall and to the engineers details and including locking latch suitable for padlocking.	1	No		
	Framed Steel Roof Structure				
	Hollow section steel of various sizes cut to size with welded and/or bolted connections including hoisting and fixing and primed in grey oxide;				
B	40 x 40 x 1.2mm SHS rafters	12	LM		
C	Ditto beam over vertical members to support the roof	9	LM		
D	Ditto struts and ties	3	LM		
E	Ditto purlins	21	LM		
	Roof Covering				
F	28 Gauge box profile pre-painted sheet in roof covering 100 mm lap and 75 mm side laps screwed to purlins using self-drilling screws with rubber caps	21	SM		
G	28 gauge pre-painted ridge cap	7	LM		
	Painting Works				
	Prepare surfaces and apply one coat of approved primer and two finishing coats oil based/gloss paint to general surface of metal				
H	Roof and wall steel members not exceeding 50mm girth	342	LM		
	Concrete Ramp				
J	Allow for 2000mm wide concrete ramp at the entrance at a 10 degrees slope	1	ITEM		
	Total carried down to collection below				
	Collection:				
	Total brought forward from page 6				
	Total brought down from above				
	Total for SUPERSTRUCTURES carried to summary on page 12				

No	Description	Qty	Unit	Rate	Amount (KShs)
	ELEMENT No.3: FINISHES				
	WALL FINISHES				
	19mm thick cement and sand (1:4) gauged plaster on stone wall steel trowelled to:-				
A	Walls internally	20	SM		
B	Beam and walls above the beam externally	2	SM		
	Prepare and apply two undercoats and one finishing coat of plastic vinyl emulsion paint to:-				
C	Plastered walls internally and externally	22	SM		
	FLOOR FINISH:				
D	25mm thick cement screed to receive terrazzo finish	13	SM		
E	Terrazzo floor finish on screeded floor	13	SM		
	Total for FINISHES carried to summary on page 12				

No	Description	Qty	Unit	Rate	Amount (KShs)
	<p>ELEMENT No.4: ELECTRICAL INSTALLATION WORKS</p> <p>Note: The work under this element is to be carried out by a registered electrical subcontractor subject to the approval</p> <p>Supply, install test and commission in accordance to BS 7671:1998, the following as described below:</p> <p>LIGHTING INSTALLATION</p> <p>Lighting points wired in 3 x 1.5 sq.mm PVC insulated single core copper cable drawn in 20mm dia. PVC Heavy gauge conduit concealed in walls, for two way switching, where the total distance to between light and switch is 5 metres</p> <p>10A 240V wall mounted switch plates as legrand or equal and approved as described</p> <p>One gang one way</p> <p>Supply and install the following lighting fixtures complete with the control switchgears and lamp as per description and symbols:</p> <p>1x 2ft LED fluorescent fittings surface mounted as Power Technics Manufacture or equal and approved type 48</p> <p>SMALL POWER INSTALLATION</p> <p>Ring mains circuit power points wired in 3 x 2.5 sq.mm PVC insulated single core copper cable draw 20 mm heavy gauge conduits concealed in walls, total distance between the sockets is 10 metres</p> <p>240V white moulded socket plates as Legrand or equal and approved as described</p> <p>13A twin standard socket</p> <p>POWER DISTRIBUTION AND SUBMAINS INSTALLATION</p> <p>4 Ways 63A DP flush mounted consumer unit CCU</p> <p>MCBs for the items above</p> <p>10A SP for lighting</p> <p>30A SP for sockets</p>				
A	Lighting points wired in 3 x 1.5 sq.mm PVC insulated single core copper cable drawn in 20mm dia. PVC Heavy gauge conduit concealed in walls, for two way switching, where the total distance to between light and switch is 5 metres	1	NO		
B	10A 240V wall mounted switch plates as legrand or equal and approved as described One gang one way	1	No		
C	Supply and install the following lighting fixtures complete with the control switchgears and lamp as per description and symbols: 1x 2ft LED fluorescent fittings surface mounted as Power Technics Manufacture or equal and approved type 48	1	No		
D	Ring mains circuit power points wired in 3 x 2.5 sq.mm PVC insulated single core copper cable draw 20 mm heavy gauge conduits concealed in walls, total distance between the sockets is 10 metres	1	No		
E	240V white moulded socket plates as Legrand or equal and approved as described	1	No		
F	13A twin standard socket	1	No		
G	4 Ways 63A DP flush mounted consumer unit CCU	1	No		
A	MCBs for the items above 10A SP for lighting	1	No		
B	30A SP for sockets	1	No		
	Total carried to collection on page 10				

No	Description	Qty	Unit	Rate	Amount (KShs)
C	Blanking plates	2	No		
D	Provide material for cabling to consumer units from hospital DB 2.5mm sqd TWE in 20 mm h/g conduits running on the surface with saddle clips	50	LM		
E	Saddle clips 20 mm	20	Pcs		
	Total carried down to collection below				
	<p>Collection:</p> <p>Total brought forward from page 9</p> <p>Total brought down from above</p>				
	Total for ELECTRICAL INSTALATION WORKS carried to summary on page 12				

No	Description	Qty	Unit	Rate	Amount (KShs)
A	<p>ELEMENT NO.5: PROVISIONAL SUMS</p> <p>Allow a Provisional sum of Kenya Twent Five Thousand (Kshs. 25,000/=) only for Contigencies</p>	1	ITEM		
	<p>Total for PROVISIONAL SUMS carried to summary on page 12</p>				

Summary Page

No	Description	Amount (KShs)
5	Total for SUBSTRUCURES brought forward from page 5	
5	Total for SUPERSTRUCTURES brought forward from page 7	
5	Total for FINISHES brought forward from page 8	
5	Total for ELECTRICAL INSTALLATION WORKS brought forward from page 10	
5	Total for PROVISIONAL SUMS brought forward from page 11	
	Total for Bill 2 - MANIFOLD SHED carried to Facility Summary on Page 14	

No	Description	Qty	Unit	Rate	Amount (KShs)
<u>BILL 3 - CYLINDER RACK</u>					
DETAILS AND DESCRIPTION - REFER TO THE DRAWING FOR MORE CLARIFICATIONS.					
1	RHS - 2X2 INCHES, 2 MM THICKNESS	30	LM		
2	DRILLING - DRILL MOUNTING HOLES AS PER THE DRAWING	12	No.		
3	FLAT BAR - 1-1/2" X1/4"	6	LM		
4	CHAIN - GRADE 30	8	LM		
5	RAWLBOLT - M-10	10	PCS		
6	PAINTWORKS - 2 COATS SPRAY PAINTING, BLACK COLOUR	1	LTRS		
7	TOP CAPS - HDPE TO COVER 2" SQUARE HOLLOW AS	12	PCS		
8	LABOUR - CONTINUOUS WELDING, MOUNTING		Item		
Total for Bill 3 - CYLINDER RACK carried to Facility Summary on Page 14					

FACILITY SUMMARY PAGE

No	Description	Quoted Amount	Required No.	Amount (KShs)
5	Total for Bill 1 - PIPING WORKS brought forward from page 2		1	
5	Total for Bill 2 - MANIFOLD SHED brought forward from page 12		1	
5	Total for Bill 3 - CYLINDER RACK brought forward from page 13		1	
Total for Health Facility carried to LOT SUMMARY Page				

No	Description	Qty	Unit	Rate	Amount (KShs)
<u>BILL 1 - PIPING WORKS</u>					
A	Distribution systems				
1.0	Manifold : Fully automatic Medical Oxygen Gas Manifold manufactured to ISO7396-1:2016 standards, complete with two stage regulator, monitoring alarm and hose connection ports with valves, with corresponding cylinders holding racks.				
	1(a) Wall mounted manifold (10x2)	0	No		
	1(b) Wall mounted manifold (8x2)	1	No		
	1(c) Wall mounted manifold (5x2)	0	No		
2.0	Cylinder connection steel braided pig tail hoses, Corresponding to item 1a or 1b or 1c above	16	No		
B	Copper pipes and fittings: Degreased copper pipes, manufactured from phosphorus de-oxidized non- arsenical copper to conform to ISO7396-1:2016 or BS EN13348:2016				
1.0	Pipes:				
	22mm diameter degreased copper pipes in metres	136	LM		
	15mm diameter degreased copper pipes in metres	100	LM		
	12mm diameter degreased copper pipes in metres	54	LM		
2.0	Elbows:				
	22mm diameter degreased copper elbows	14	Pcs		
	15mm diameter degreased copper elbows	25	Pcs		
3.0	Couplers:				
	22mm diameter degreased copper straight couplers	68	Pcs		
	15mm diameter degreased copper straight couplers	50	Pcs		
4.0	Reducers:				
	22x15mm diameter degreased copper reducer	10	Pcs		
	15x12mm diameter degreased copper reducer	36	Pcs		
5.0	Tees:				
	22mm diameter degreased copper equal Tees	10	Pcs		
	15mm diameter degreased copper equal Tees	36	Pcs		
C	Line ball valves c/w NIST,				
1.0	22mm medical gas line valves	4	Item		
2.0	15mm medical gas line valves	2	Item		
3.0	AVSU - 15mm oxygen area valve service unit complete with gauges	1	Item		
Total carried to collection on page 2					

MFL:14386 HF: Chesongoch Mission Hospital

No	Description	Qty	Unit	Rate	Amount (KShs)
D	Medical Oxygen gas alarms				
1.0	Medical gas (oxygen only) monitoring alarm with % purity and pressure, with audio and visual display panels, conforming to ISO7396-1:2016	1	No		
E	Distribution Accessories				
1.0	22mm musen rings complete	14	No		
2.0	22mm plastic wall clamp	68	No		
3.0	15mm plastic wall clamp	50	No		
4.0	12mm plastic wall clamp	36	No		
5.0	M10 threaded rod	5	LM		
6.0	M10 hungers	20	No		
F	Oxygen terminal outlets, wall mount as per specifications IN THIS DOCUMENT	36	No		
G	1) Trunking for contingencies.	0	LM		
	2) Conduits for contingencies.	13	LM		
H	Provisional Sums - 50,000				
1.0	Allow for permanent and temporary identification of pipelines, valves.		Item		
2.0	PURGING: Allow for flushing the whole system with medical gases in accordance with ISO7396-1:2016 and to the satisfaction of the project Engineers. Purging is to be done using an inert gas such as Nitrogen.		Item		
3.0	TESTING AND COMMISSIONING: Allow for testing and commissioning of the entire medical gas pipeline system (using an inert gas such as Nitrogen), in accordance with the particular specification and to the satisfaction of the project Engineer, based on the (ISO7396-1:2016). The test such as pressure, leakage results duly recorded and clearly qualified in the commissioning report.		Item		
I	LABOUR COST		Item		
	Total carried to collection below				
	Collection:				
1.0	Total brought forward from page 1				
2.0	Total brought down from above				
	Total for Bill 1 - PIPING WORKS carried to Facility Summary on Page 14				

No	Description	Qty	Unit	Rate	Amount (KShs)
<u>BILL 2 - MANIFOLD SHED</u>					
ELEMENT No.1: SUBSTRUCTURES					
(ALL PROVISIONAL)					
EXCAVATION & FILLING					
Excavation					
A	Excavate 300mm deep to remove vegetable soil, load, wheel and deposit on site where directed.	24	SM		
B	Excavate to reduced levels 300mm (deep)	8	CM		
C	Excavate 60mm wide trench commencing from stripped level and not exceeding 600mm from reduced level	6	CM		
Plunking and Strutting					
D	Plunking and Strutting to sides of all excavations including keeping excavations free from all fallen materials	1	ITEM		
Disposal of water					
E	Allow for keeping excavations free from water all over	1	ITEM		
Fillings					
F	Return fill and compact selected excavated earthfilling in foundation to make up levels	3	CM		
Approved Murram/Red Soil Filling					
G	300mm thick approved murrum or red soil back filling; well rolled and compacted in 2 layers not exceeding 150mm deep to 96% compaction at optimum moisture content to bring up levels.	3	CM		
Approved Imported Filling					
H	300mm thick approved imported hardcore filling; well rolled and compacted in 2 layers not exceeding 150mm deep to 96% compaction at optimum moisture content	3	CM		
J	50mm thick quality murrum blinding on surfaces of hardcore	9	SM		
Disposal of Surplus Spoil:-					
K	Load and cart away surplus spoil from the site and deposit the same away from site where directed to approved dumping site	3	CM		
Total carried to collection on page 5					-

No	Description	Qty	Unit	Rate	Amount (KShs)
A	Anti-Termite Treatment Chemical anti-termites treatment to subsoil or filling: RENTOKIL. or equal approved: provide a ten year guarantee	9	SM		
B	Damp Proof Membrane 1000g Polythene damp proof membrane laid under floor bed with 300mm side and end lap (measured nett allow for laps)	13	SM		
SUBSTRUCTURE CONCRETE WORKS					
<u>Plain concrete class 15 (mix 1:3:6) as described, in:-</u>					
C	50mm thick surface blinding under strip footing and column bases	10	SM		
<u>In situ concrete class 25/20 , vibrated and reinforced as described, in:-</u>					
D	150mm thick strip footing	2	CM		
E	150mm thick floor slab	13	SM		
Reinforcement <u>High tensile steel reinforcement to B.S. 4449:2005 in structural concrete work including cutting, bending, hoisting, fixing, tying wire and spacing blocks in strip Footing</u>					
F	T10 (main bars)	30	KG		
G	T8 (binders)	20	KG		
<u>Mesh fabric reinforcement to B.S. 4483 and setting in concrete with 300mm side and end laps (measured nett-allow for laps)</u>					
H	Fabric mesh ref: A65 in floor bed	13	SM		
<u>Sawn formwork to:-</u>					
J	Ditto edges of slabs, girth 75mm-150mm high	17	LM		
Masonry Works -Substructures <u>Load bearing natural stone walling, jointed in cement and sand (1:4) mortar with and including No. 20 gauge hoop iron ties 450mm long x 25mm wide bent and tacked into formwork with one end cast into concrete and straightened after removal of formwork and built into mortar joint of walling.</u>					
K	200mm thick wall in foundations	17	SM		
Total carried to collection on page 5					

No	Description	Qty	Unit	Rate	Amount (KShs)
	Plinth Finishing				
A	15mm thick cement, sand (1:4) render to plinth	5	SM		
B	Prepare and apply two undercoats and one finishing coat of first grade bituminous paint or equal approved on rendered plinth	5	SM		
	Total carried down to collection below				
	<u>Collection</u> Brought forward from page 3 Brought forward from page 4 Brought down from above				
	Total for SUBSTRUCTURES carried to summary on page 12				

No	Description	Qty	Unit	Rate	Amount (KShs)
	ELEMENT No.2: SUPERSTRUCTURES				
A	Damp Proof Course 200mm wide bituminous felt as damp proof course and including 200mm laps	7.2	LM		
	Masonry Works -Superstructures Machine cut natural stone / concrete block wall; load bearing 7.0 N/mm ² ; bedded and jointed in cement and sand (1:4) mortar reinforced with 25mm x 20mm gauge hoop iron at every alternate course as described in;				
B	200mm thick walling	18	SM		
	Concrete Beam Insitu concrete class 25/20 , vibrated and reinforced as described, in	2	CM		
C	200 x200mm beam				
	High tensile steel reinforcement to B.S. 4449:2005 in structural concrete work including cutting, bending, hoisting, fixing, tying wire and spacing blocks in beam				
D	T10 (main bars - 4No)	18	KG		
	T8 (binders @200c/c)	10	KG		
	Pallisade walling <u>Mild steel pallisade walling in:-</u>				
E	40 x 40 x 1.2mm thick SHS vertical members securely fixed to ground slab at every coner and ends welding to roof rails (floor and roof height 2400mm) 6No.	15	LM		
F	40 x 40 x 1.2mm thick SHS horizontal members fixed to same size vertical member (m.s) by welding in 3 rows (top centre and bolttom as per the design	38	LM		
G	2100mm long 25 x 25 x 1.2mm thick SHS, vertical members fixed at 150 centre to centre including assembly and welding to horizontal members (ms) with an offset of 75mm from finished floor level	164	LM		
	Rain water goods				
H	Supply 140 mm U-shaped plastic gutters including necessary accessories such as brackets, end caps, and downspouts, and fix using appropriate fasteners.	7	LM		
J	75mm dia PVC downpipes	5	LM		
K	Ditto but 45° bend	4	No		
	Total carried to collection on page 7				

No	Description	Qty	Unit	Rate	Amount (KShs)
	Steel Door				
	<u>Fabricated to same matching design to pallisade walling:</u>				
A	2000mm wide double leaf steel door fabricated in 40x40x1.2mm thick SHS leaf vertical edge members (2100mm high) and 3 rows horizontal members and 25x25x1.2mm SHS 2100mm high vertical members at 150mm centre to centre synchronising in pattern to the pallisade wall and to the engineers details and including locking latch suitable for padlocking.	1	No		
	Framed Steel Roof Structure				
	Hollow section steel of various sizes cut to size with welded and/or bolted connections including hoisting and fixing and primed in grey oxide;				
B	40 x 40 x 1.2mm SHS rafters	12	LM		
C	Ditto beam over vertical members to support the roof	9	LM		
D	Ditto struts and ties	3	LM		
E	Ditto purlins	21	LM		
	Roof Covering				
F	28 Gauge box profile pre-painted sheet in roof covering 100 mm lap and 75 mm side laps screwed to purlins using self-drilling screws with rubber caps	21	SM		
G	28 gauge pre-painted ridge cap	7	LM		
	Painting Works				
	Prepare surfaces and apply one coat of approved primer and two finishing coats oil based/gloss paint to general surface of metal				
H	Roof and wall steel members not exceeding 50mm girth	342	LM		
	Concrete Ramp				
J	Allow for 2000mm wide concrete ramp at the entrance at a 10 degrees slope	1	ITEM		
	Total carried down to collection below				
	Collection:				
	Total brought forward from page 6				
	Total brought down from above				
	Total for SUPERSTRUCTURES carried to summary on page 12				

No	Description	Qty	Unit	Rate	Amount (KShs)
	ELEMENT No.3: FINISHES				
	WALL FINISHES				
	19mm thick cement and sand (1:4) gauged plaster on stone wall steel trowelled to:-				
A	Walls internally	20	SM		
B	Beam and walls above the beam externally	2	SM		
	Prepare and apply two undercoats and one finishing coat of plastic vinyl emulsion paint to:-				
C	Plastered walls internally and externally	22	SM		
	FLOOR FINISH:				
D	25mm thick cement screed to receive terrazzo finish	13	SM		
E	Terrazzo floor finish on screeded floor	13	SM		
	Total for FINISHES carried to summary on page 12				

No	Description	Qty	Unit	Rate	Amount (KShs)
	<p>ELEMENT No.4: ELECTRICAL INSTALLATION WORKS</p> <p>Note: The work under this element is to be carried out by a registered electrical subcontractor subject to the approval</p> <p>Supply, install test and commission in accordance to BS 7671:1998, the following as described below:</p> <p>LIGHTING INSTALLATION</p> <p>Lighting points wired in 3 x 1.5 sq.mm PVC insulated single core copper cable drawn in 20mm dia. PVC Heavy gauge conduit concealed in walls, for two way switching, where the total distance to between light and switch is 5 metres</p> <p>10A 240V wall mounted switch plates as legrand or equal and approved as described</p> <p>One gang one way</p> <p>Supply and install the following lighting fixtures complete with the control switchgears and lamp as per description and symbols:</p> <p>1x 2ft LED fluorescent fittings surface mounted as Power Technics Manufacture or equal and approved type 48</p> <p>SMALL POWER INSTALLATION</p> <p>Ring mains circuit power points wired in 3 x 2.5 sq.mm PVC insulated single core copper cable draw 20 mm heavy gauge conduits concealed in walls, total distance between the sockets is 10 metres</p> <p>240V white moulded socket plates as Legrand or equal and approved as described</p> <p>13A twin standard socket</p> <p>POWER DISTRIBUTION AND SUBMAINS INSTALLATION</p> <p>4 Ways 63A DP flush mounted consumer unit CCU</p> <p>MCBs for the items above</p> <p>10A SP for lighting</p> <p>30A SP for sockets</p>				
A		1	NO		
B		1	No		
C		1	No		
D		1	No		
E		1	No		
F		1	No		
G		1	No		
A		1	No		
B		1	No		
	Total carried to collection on page 10				

No	Description	Qty	Unit	Rate	Amount (KShs)
C	Blanking plates	2	No		
D	Provide material for cabling to consumer units from hospital DB 2.5mm sqd TWE in 20 mm h/g conduits running on the surface with saddle clips	50	LM		
E	Saddle clips 20 mm	20	Pcs		
Total carried down to collection below					
<p>Collection:</p> <p>Total brought forward from page 9</p> <p>Total brought down from above</p>					
Total for ELECTRICAL INSTALATION WORKS carried to summary on page 12					

No	Description	Qty	Unit	Rate	Amount (KShs)
A	<p>ELEMENT NO.5: PROVISIONAL SUMS</p> <p>Allow a Provisional sum of Kenya Twent Five Thousand (Kshs. 25,000/=) only for Contigencies</p>	1	ITEM		
	<p>Total for PROVISIONAL SUMS carried to summary on page 12</p>				

Summary Page

No	Description	Amount (KShs)
5	Total for SUBSTRUCURES brought forward from page 5	
5	Total for SUPERSTRUCTURES brought forward from page 7	
5	Total for FINISHES brought forward from page 8	
5	Total for ELECTRICAL INSTALLATION WORKS brought forward from page 10	
5	Total for PROVISIONAL SUMS brought forward from page 11	
	Total for Bill 2 - MANIFOLD SHED carried to Facility Summary on Page 14	

No	Description	Qty	Unit	Rate	Amount (KShs)
<u>BILL 3 - CYLINDER RACK</u>					
DETAILS AND DESCRIPTION - REFER TO THE DRAWING FOR MORE CLARIFICATIONS.					
1	RHS - 2X2 INCHES, 2 MM THICKNESS	30	LM		
2	DRILLING - DRILL MOUNTING HOLES AS PER THE DRAWING	12	No.		
3	FLAT BAR - 1-1/2" X1/4"	6	LM		
4	CHAIN - GRADE 30	8	LM		
5	RAWLBOLT - M-10	10	PCS		
6	PAINTWORKS - 2 COATS SPRAY PAINTING, BLACK COLOUR	1	LTRS		
7	TOP CAPS - HDPE TO COVER 2" SQUARE HOLLOW AS	12	PCS		
8	LABOUR - CONTINUOUS WELDING, MOUNTING		Item		
Total for Bill 3 - CYLINDER RACK carried to Facility Summary on Page 14					

FACILITY SUMMARY PAGE

No	Description	Quoted Amount	Required No.	Amount (KShs)
5	Total for Bill 1 - PIPING WORKS brought forward from page 2		1	
5	Total for Bill 2 - MANIFOLD SHED brought forward from page 12		1	
5	Total for Bill 3 - CYLINDER RACK brought forward from page 13		1	
Total for Health Facility carried to LOT SUMMARY Page				

No	Description	Qty	Unit	Rate	Amount (KShs)
<u>BILL 1 - PIPING WORKS</u>					
A	Distribution systems				
1.0	Manifold : Fully automatic Medical Oxygen Gas Manifold manufactured to ISO7396-1:2016 standards, complete with two stage regulator, monitoring alarm and hose connection ports with valves, with corresponding cylinders holding racks.				
	1(a) Wall mounted manifold (10x2)	0	No		
	1(b) Wall mounted manifold (8x2)	1	No		
	1(c) Wall mounted manifold (5x2)	0	No		
2.0	Cylinder connection steel braided pig tail hoses, Corresponding to item 1a or 1b or 1c above	16	No		
B	Copper pipes and fittings: Degreased copper pipes, manufactured from phosphorus de-oxidized non- arsenical copper to conform to ISO7396-1:2016 or BS EN13348:2016				
1.0	Pipes:				
	22mm diameter degreased copper pipes in metres	80	LM		
	15mm diameter degreased copper pipes in metres	81	LM		
	12mm diameter degreased copper pipes in metres	150	LM		
2.0	Elbows:				
	22mm diameter degreased copper elbows	8	Pcs		
	15mm diameter degreased copper elbows	21	Pcs		
3.0	Couplers:				
	22mm diameter degreased copper straight couplers	40	Pcs		
	15mm diameter degreased copper straight couplers	41	Pcs		
4.0	Reducers:				
	22x15mm diameter degreased copper reducer	10	Pcs		
	15x12mm diameter degreased copper reducer	100	Pcs		
5.0	Tees:				
	22mm diameter degreased copper equal Tees	10	Pcs		
	15mm diameter degreased copper equal Tees	100	Pcs		
C	Line ball valves c/w NIST,				
1.0	22mm medical gas line valves	4	Item		
2.0	15mm medical gas line valves	4	Item		
3.0	AVSU - 15mm oxygen area valve service unit complete with gauges	1	Item		
Total carried to collection on page 2					

MFL:14178 HF: AIC Litein Mission Hospital

No	Description	Qty	Unit	Rate	Amount (KShs)
D	Medical Oxygen gas alarms				
1.0	Medical gas (oxygen only) monitoring alarm with % purity and pressure, with audio and visual display panels, conforming to ISO7396-1:2016	2	No		
E	Distribution Accessories				
1.0	22mm musen rings complete	8	No		
2.0	22mm plastic wall clamp	40	No		
3.0	15mm plastic wall clamp	41	No		
4.0	12mm plastic wall clamp	100	No		
5.0	M10 threaded rod	5	LM		
6.0	M10 hungers	20	No		
F	Oxygen terminal outlets, wall mount as per specifications IN THIS DOCUMENT	100	No		
G	1) Trunking for contingencies.	0	LM		
	2) Conduits for contingencies.	58	LM		
H	Provisional Sums - 50,000				
1.0	Allow for permanent and temporary identification of pipelines, valves.		Item		
2.0	PURGING: Allow for flushing the whole system with medical gases in accordance with ISO7396-1:2016 and to the satisfaction of the project Engineers. Purging is to be done using an inert gas such as Nitrogen.		Item		
3.0	TESTING AND COMMISSIONING: Allow for testing and commissioning of the entire medical gas pipeline system (using an inert gas such as Nitrogen), in accordance with the particular specification and to the satisfaction of the project Engineer, based on the (ISO7396-1:2016). The test such as pressure, leakage results duly recorded and clearly qualified in the commissioning report.		Item		
I	LABOUR COST		Item		
	Total carried to collection below				
	Collection:				
1.0	Total brought forward from page 1				
2.0	Total brought down from above				
	Total for Bill 1 - PIPING WORKS carried to Facility Summary on Page 14				

No	Description	Qty	Unit	Rate	Amount (KShs)
<u>BILL 2 - MANIFOLD SHED</u>					
ELEMENT No.1: SUBSTRUCTURES					
(ALL PROVISIONAL)					
EXCAVATION & FILLING					
Excavation					
A	Excavate 300mm deep to remove vegetable soil, load, wheel and deposit on site where directed.	24	SM		
B	Excavate to reduced levels 300mm (deep)	8	CM		
C	Excavate 60mm wide trench commencing from stripped level and not exceeding 600mm from reduced level	6	CM		
Plunking and Strutting					
D	Plunking and Strutting to sides of all excavations including keeping excavations free from all fallen materials	1	ITEM		
Disposal of water					
E	Allow for keeping excavations free from water all over	1	ITEM		
Fillings					
F	Return fill and compact selected excavated earthfilling in foundation to make up levels	3	CM		
Approved Murram/Red Soil Filling					
G	300mm thick approved murrum or red soil back filling; well rolled and compacted in 2 layers not exceeding 150mm deep to 96% compaction at optimum moisture content to bring up levels.	3	CM		
Approved Imported Filling					
H	300mm thick approved imported hardcore filling; well rolled and compacted in 2 layers not exceeding 150mm deep to 96% compaction at optimum moisture content	3	CM		
J	50mm thick quality murrum blinding on surfaces of hardcore	9	SM		
Disposal of Surplus Spoil:-					
K	Load and cart away surplus spoil from the site and deposit the same away from site where directed to approved dumping site	3	CM		
Total carried to collection on page 5					-

No	Description	Qty	Unit	Rate	Amount (KShs)
A	Anti-Termite Treatment Chemical anti-termite treatment to subsoil or filling: RENTOKIL. or equal approved: provide a ten year guarantee	9	SM		
B	Damp Proof Membrane 1000g Polythene damp proof membrane laid under floor bed with 300mm side and end lap (measured nett allow for laps)	13	SM		
SUBSTRUCTURE CONCRETE WORKS					
<u>Plain concrete class 15 (mix 1:3:6) as described, in:-</u>					
C	50mm thick surface blinding under strip footing and column bases	10	SM		
<u>In situ concrete class 25/20 , vibrated and reinforced as described, in:-</u>					
D	150mm thick strip footing	2	CM		
E	150mm thick floor slab	13	SM		
Reinforcement <u>High tensile steel reinforcement to B.S. 4449:2005 in structural concrete work including cutting, bending, hoisting, fixing, tying wire and spacing blocks in strip Footing</u>					
F	T10 (main bars)	30	KG		
G	T8 (binders)	20	KG		
<u>Mesh fabric reinforcement to B.S. 4483 and setting in concrete with 300mm side and end laps (measured nett-allow for laps)</u>					
H	Fabric mesh ref: A65 in floor bed	13	SM		
<u>Sawn formwork to:-</u>					
J	Ditto egdes of slabs, girth 75mm-150mm high	17	LM		
Masonry Works -Substructures <u>Load bearing natural stone walling, jointed in cement and sand (1:4) mortar with and including No. 20 gauge hoop iron ties 450mm long x 25mm wide bent and tacked into formwork with one end cast into concrete and straightened after removal of formwork and built into mortar joint of walling.</u>					
K	200mm thick wall in foundations	17	SM		
Total carried to collection on page 5					

No	Description	Qty	Unit	Rate	Amount (KShs)
	Plinth Finishing				
A	15mm thick cement, sand (1:4) render to plinth	5	SM		
B	Prepare and apply two undercoats and one finishing coat of first grade bituminous paint or equal approved on rendered plinth	5	SM		
	Total carried down to collection below				
	<u>Collection</u> Brought forward from page 3 Brought forward from page 4 Brought down from above				
	Total for SUBSTRUCTURES carried to summary on page 12				

No	Description	Qty	Unit	Rate	Amount (KShs)
	ELEMENT No.2: SUPERSTRUCTURES				
A	Damp Proof Course 200mm wide bituminous felt as damp proof course and including 200mm laps	7.2	LM		
	Masonry Works -Superstructures Machine cut natural stone / concrete block wall; load bearing 7.0 N/mm ² ; bedded and jointed in cement and sand (1:4) mortar reinforced with 25mm x 20mm gauge hoop iron at every alternate course as described in;				
B	200mm thick walling	18	SM		
	Concrete Beam Insitu concrete class 25/20 , vibrated and reinforced as described, in	2	CM		
C	200 x200mm beam				
	High tensile steel reinforcement to B.S. 4449:2005 in structural concrete work including cutting, bending, hoisting, fixing, tying wire and spacing blocks in beam				
D	T10 (main bars - 4No)	18	KG		
	T8 (binders @200c/c)	10	KG		
	Pallisade walling <u>Mild steel pallisade walling in:-</u>				
E	40 x 40 x 1.2mm thick SHS vertical members securely fixed to ground slab at every coner and ends welding to roof rails (floor and roof height 2400mm) 6No.	15	LM		
F	40 x 40 x 1.2mm thick SHS horizontal members fixed to same size vertical member (m.s) by welding in 3 rows (top centre and bolttom as per the design	38	LM		
G	2100mm long 25 x 25 x 1.2mm thick SHS, vertical members fixed at 150 centre to centre including assembly and welding to horizontal members (ms) with an offset of 75mm from finished floor level	164	LM		
	Rain water goods				
H	Supply 140 mm U-shaped plastic gutters including necessary accessories such as brackets, end caps, and downspouts, and fix using appropriate fasteners.	7	LM		
J	75mm dia PVC downpipes	5	LM		
K	Ditto but 45° bend	4	No		
	Total carried to collection on page 7				

No	Description	Qty	Unit	Rate	Amount (KShs)
	Steel Door				
	<u>Fabricated to same matching design to pallisade walling:</u>				
A	2000mm wide double leaf steel door fabricated in 40x40x1.2mm thick SHS leaf vertical edge members (2100mm high) and 3 rows horizontal members and 25x25x1.2mm SHS 2100mm high vertical members at 150mm centre to centre synchronising in pattern to the pallisade wall and to the engineers details and including locking latch suitable for padlocking.	1	No		
	Framed Steel Roof Structure				
	Hollow section steel of various sizes cut to size with welded and/or bolted connections including hoisting and fixing and primed in grey oxide;				
B	40 x 40 x 1.2mm SHS rafters	12	LM		
C	Ditto beam over vertical members to support the roof	9	LM		
D	Ditto struts and ties	3	LM		
E	Ditto purlins	21	LM		
	Roof Covering				
F	28 Gauge box profile pre-painted sheet in roof covering 100 mm lap and 75 mm side laps screwed to purlins using self-drilling screws with rubber caps	21	SM		
G	28 gauge pre-painted ridge cap	7	LM		
	Painting Works				
	Prepare surfaces and apply one coat of approved primer and two finishing coats oil based/gloss paint to general surface of metal				
H	Roof and wall steel members not exceeding 50mm girth	342	LM		
	Concrete Ramp				
J	Allow for 2000mm wide concrete ramp at the entrance at a 10 degrees slope	1	ITEM		
	Total carried down to collection below				
	Collection:				
	Total brought forward from page 6				
	Total brought down from above				
	Total for SUPERSTRUCTURES carried to summary on page 12				

No	Description	Qty	Unit	Rate	Amount (KShs)
	ELEMENT No.3: FINISHES				
	WALL FINISHES				
	19mm thick cement and sand (1:4) gauged plaster on stone wall steel trowelled to:-				
A	Walls internally	20	SM		
B	Beam and walls above the beam externally	2	SM		
	Prepare and apply two undercoats and one finishing coat of plastic vinyl emulsion paint to:-				
C	Plastered walls internally and externally	22	SM		
	FLOOR FINISH:				
D	25mm thick cement screed to receive terrazzo finish	13	SM		
E	Terrazzo floor finish on screeded floor	13	SM		
	Total for FINISHES carried to summary on page 12				

No	Description	Qty	Unit	Rate	Amount (KShs)
	<p>ELEMENT No.4: ELECTRICAL INSTALLATION WORKS</p> <p>Note: The work under this element is to be carried out by a registered electrical subcontractor subject to the approval</p> <p>Supply, install test and commission in accordance to BS 7671:1998, the following as described below:</p> <p>LIGHTING INSTALLATION</p> <p>Lighting points wired in 3 x 1.5 sq.mm PVC insulated single core copper cable drawn in 20mm dia. PVC Heavy gauge conduit concealed in walls, for two way switching, where the total distance to between light and switch is 5 metres</p> <p>10A 240V wall mounted switch plates as legrand or equal and approved as described</p> <p>One gang one way</p> <p>Supply and install the following lighting fixtures complete with the control switchgears and lamp as per description and symbols:</p> <p>1x 2ft LED fluorescent fittings surface mounted as Power Technics Manufacture or equal and approved type 48</p> <p>SMALL POWER INSTALLATION</p> <p>Ring mains circuit power points wired in 3 x 2.5 sq.mm PVC insulated single core copper cable draw 20 mm heavy gauge conduits concealed in walls, total distance between the sockets is 10 metres</p> <p>240V white moulded socket plates as Legrand or equal and approved as described</p> <p>13A twin standard socket</p> <p>POWER DISTRIBUTION AND SUBMAINS INSTALLATION</p> <p>4 Ways 63A DP flush mounted consumer unit CCU</p> <p>MCBs for the items above</p> <p>10A SP for lighting</p> <p>30A SP for sockets</p>				
A	Lighting points wired in 3 x 1.5 sq.mm PVC insulated single core copper cable drawn in 20mm dia. PVC Heavy gauge conduit concealed in walls, for two way switching, where the total distance to between light and switch is 5 metres	1	NO		
B	10A 240V wall mounted switch plates as legrand or equal and approved as described One gang one way	1	No		
C	Supply and install the following lighting fixtures complete with the control switchgears and lamp as per description and symbols: 1x 2ft LED fluorescent fittings surface mounted as Power Technics Manufacture or equal and approved type 48	1	No		
D	Ring mains circuit power points wired in 3 x 2.5 sq.mm PVC insulated single core copper cable draw 20 mm heavy gauge conduits concealed in walls, total distance between the sockets is 10 metres	1	No		
E	240V white moulded socket plates as Legrand or equal and approved as described	1	No		
F	13A twin standard socket	1	No		
G	4 Ways 63A DP flush mounted consumer unit CCU	1	No		
A	10A SP for lighting	1	No		
B	30A SP for sockets	1	No		
	Total carried to collection on page 10				

No	Description	Qty	Unit	Rate	Amount (KShs)
C	Blanking plates	2	No		
D	Provide material for cabling to consumer units from hospital DB 2.5mm sqd TWE in 20 mm h/g conduits running on the surface with saddle clips	50	LM		
E	Saddle clips 20 mm	20	Pcs		
	Total carried down to collection below				
	<p>Collection:</p> <p>Total brought forward from page 9</p> <p>Total brought down from above</p>				
	Total for ELECTRICAL INSTALATION WORKS carried to summary on page 12				

No	Description	Qty	Unit	Rate	Amount (KShs)
A	<p>ELEMENT NO.5: PROVISIONAL SUMS</p> <p>Allow a Provisional sum of Kenya Twent Five Thousand (Kshs. 25,000/=) only for Contigencies</p>	1	ITEM		
	<p>Total for PROVISIONAL SUMS carried to summary on page 12</p>				

Summary Page

No	Description	Amount (KShs)
5	Total for SUBSTRUCURES brought forward from page 5	
5	Total for SUPERSTRUCTURES brought forward from page 7	
5	Total for FINISHES brought forward from page 8	
5	Total for ELECTRICAL INSTALLATION WORKS brought forward from page 10	
5	Total for PROVISIONAL SUMS brought forward from page 11	
	Total for Bill 2 - MANIFOLD SHED carried to Facility Summary on Page 14	

No	Description	Qty	Unit	Rate	Amount (KShs)
<u>BILL 3 - CYLINDER RACK</u>					
DETAILS AND DESCRIPTION - REFER TO THE DRAWING FOR MORE CLARIFICATIONS.					
1	RHS - 2X2 INCHES, 2 MM THICKNESS	30	LM		
2	DRILLING - DRILL MOUNTING HOLES AS PER THE DRAWING	12	No.		
3	FLAT BAR - 1-1/2" X1/4"	6	LM		
4	CHAIN - GRADE 30	8	LM		
5	RAWLBOLT - M-10	10	PCS		
6	PAINTWORKS - 2 COATS SPRAY PAINTING, BLACK COLOUR	1	LTRS		
7	TOP CAPS - HDPE TO COVER 2" SQUARE HOLLOW AS	12	PCS		
8	LABOUR - CONTINUOUS WELDING, MOUNTING		Item		
Total for Bill 3 - CYLINDER RACK carried to Facility Summary on Page 14					

FACILITY SUMMARY PAGE

No	Description	Quoted Amount	Required No.	Amount (KShs)
5	Total for Bill 1 - PIPING WORKS brought forward from page 2		1	
5	Total for Bill 2 - MANIFOLD SHED brought forward from page 12		1	
5	Total for Bill 3 - CYLINDER RACK brought forward from page 13		1	
Total for Health Facility carried to LOT SUMMARY Page				

No	Description	Qty	Unit	Rate	Amount (KShs)
<u>BILL 1 - PIPING WORKS</u>					
A	Distribution systems				
1.0	Manifold : Fully automatic Medical Oxygen Gas Manifold manufactured to ISO7396-1:2016 standards, complete with two stage regulator, monitoring alarm and hose connection ports with valves, with corresponding cylinders holding racks.				
	1(a) Wall mounted manifold (10x2)	1	No		
	1(b) Wall mounted manifold (8x2)	0	No		
	1(c) Wall mounted manifold (5x2)	0	No		
2.0	Cylinder connection steel braided pig tail hoses, Corresponding to item 1a or 1b or 1c above	20	No		
B	Copper pipes and fittings: Degreased copper pipes, manufactured from phosphorus de-oxidized non- arsenical copper to conform to ISO7396-1:2016 or BS EN13348:2016				
1.0	Pipes:				
	22mm diameter degreased copper pipes in metres	283	LM		
	15mm diameter degreased copper pipes in metres	130	LM		
	12mm diameter degreased copper pipes in metres	113	LM		
2.0	Elbows:				
	22mm diameter degreased copper elbows	29	Pcs		
	15mm diameter degreased copper elbows	33	Pcs		
3.0	Couplers:				
	22mm diameter degreased copper straight couplers	142	Pcs		
	15mm diameter degreased copper straight couplers	65	Pcs		
4.0	Reducers:				
	22x15mm diameter degreased copper reducer	10	Pcs		
	15x12mm diameter degreased copper reducer	75	Pcs		
5.0	Tees:				
	22mm diameter degreased copper equal Tees	10	Pcs		
	15mm diameter degreased copper equal Tees	75	Pcs		
C	Line ball valves c/w NIST,				
1.0	22mm medical gas line valves	2	Item		
2.0	15mm medical gas line valves	4	Item		
3.0	AVSU - 15mm oxygen area valve service unit complete with gauges	2	Item		
Total carried to collection on page 2					

MFL:15174 HF: Mercy Mission Hospital

No	Description	Qty	Unit	Rate	Amount (KShs)
D	Medical Oxygen gas alarms				
1.0	Medical gas (oxygen only) monitoring alarm with % purity and pressure, with audio and visual display panels, conforming to ISO7396-1:2016	1	No		
E	Distribution Accessories				
1.0	22mm musen rings complete	29	No		
2.0	22mm plastic wall clamp	142	No		
3.0	15mm plastic wall clamp	65	No		
4.0	12mm plastic wall clamp	75	No		
5.0	M10 threaded rod	5	LM		
6.0	M10 hungers	20	No		
F	Oxygen terminal outlets, wall mount as per specifications IN THIS DOCUMENT	75	No		
G	1) Trunking for contingencies.	0	LM		
	2) Conduits for contingencies.	0	LM		
H	Provisional Sums - 50,000				
1.0	Allow for permanent and temporary identification of pipelines, valves.		Item		
2.0	PURGING: Allow for flushing the whole system with medical gases in accordance with ISO7396-1:2016 and to the satisfaction of the project Engineers. Purging is to be done using an inert gas such as Nitrogen.		Item		
3.0	TESTING AND COMMISSIONING: Allow for testing and commissioning of the entire medical gas pipeline system (using an inert gas such as Nitrogen), in accordance with the particular specification and to the satisfaction of the project Engineer, based on the (ISO7396-1:2016). The test such as pressure, leakage results duly recorded and clearly qualified in the commissioning report.		Item		
I	LABOUR COST		Item		
	Total carried to collection below				
	Collection:				
1.0	Total brought forward from page 1				
2.0	Total brought down from above				
	Total for Bill 1 - PIPING WORKS carried to Facility Summary on Page 14				

No	Description	Qty	Unit	Rate	Amount (KShs)
<u>BILL 2 - MANIFOLD SHED</u>					
ELEMENT No.1: SUBSTRUCTURES					
(ALL PROVISIONAL)					
EXCAVATION & FILLING					
Excavation					
A	Excavate 300mm deep to remove vegetable soil, load, wheel and deposit on site where directed.	24	SM		
B	Excavate to reduced levels 300mm (deep)	8	CM		
C	Excavate 60mm wide trench commencing from stripped level and not exceeding 600mm from reduced level	6	CM		
Plunking and Strutting					
D	Plunking and Strutting to sides of all excavations including keeping excavations free from all fallen materials	1	ITEM		
Disposal of water					
E	Allow for keeping excavations free from water all over	1	ITEM		
Fillings					
F	Return fill and compact selected excavated earthfilling in foundation to make up levels	3	CM		
Approved Murram/Red Soil Filling					
G	300mm thick approved murrum or red soil back filling; well rolled and compacted in 2 layers not exceeding 150mm deep to 96% compaction at optimum moisture content to bring up levels.	3	CM		
Approved Imported Filling					
H	300mm thick approved imported hardcore filling; well rolled and compacted in 2 layers not exceeding 150mm deep to 96% compaction at optimum moisture content	3	CM		
J	50mm thick quality murrum blinding on surfaces of hardcore	9	SM		
Disposal of Surplus Spoil:-					
K	Load and cart away surplus spoil from the site and deposit the same away from site where directed to approved dumping site	3	CM		
Total carried to collection on page 5					-

No	Description	Qty	Unit	Rate	Amount (KShs)
A	Anti-Termite Treatment Chemical anti-termite treatment to subsoil or filling: RENTOKIL. or equal approved: provide a ten year guarantee	9	SM		
B	Damp Proof Membrane 1000g Polythene damp proof membrane laid under floor bed with 300mm side and end lap (measured nett allow for laps)	13	SM		
SUBSTRUCTURE CONCRETE WORKS					
<u>Plain concrete class 15 (mix 1:3:6) as described, in:-</u>					
C	50mm thick surface blinding under strip footing and column bases	10	SM		
<u>In situ concrete class 25/20 , vibrated and reinforced as described, in:-</u>					
D	150mm thick strip footing	2	CM		
E	150mm thick floor slab	13	SM		
Reinforcement <u>High tensile steel reinforcement to B.S. 4449:2005 in structural concrete work including cutting, bending, hoisting, fixing, tying wire and spacing blocks in strip Footing</u>					
F	T10 (main bars)	30	KG		
G	T8 (binders)	20	KG		
<u>Mesh fabric reinforcement to B.S. 4483 and setting in concrete with 300mm side and end laps (measured nett-allow for laps)</u>					
H	Fabric mesh ref: A65 in floor bed	13	SM		
<u>Sawn formwork to:-</u>					
J	Ditto egdes of slabs, girth 75mm-150mm high	17	LM		
Masonry Works -Substructures <u>Load bearing natural stone walling, jointed in cement and sand (1:4) mortar with and including No. 20 gauge hoop iron ties 450mm long x 25mm wide bent and tacked into formwork with one end cast into concrete and straightened after removal of formwork and built into mortar joint of walling.</u>					
K	200mm thick wall in foundations	17	SM		
Total carried to collection on page 5					

No	Description	Qty	Unit	Rate	Amount (KShs)
	Plinth Finishing				
A	15mm thick cement, sand (1:4) render to plinth	5	SM		
B	Prepare and apply two undercoats and one finishing coat of first grade bituminous paint or equal approved on rendered plinth	5	SM		
	Total carried down to collection below				
	<u>Collection</u> Brought forward from page 3 Brought forward from page 4 Brought down from above				
	Total for SUBSTRUCTURES carried to summary on page 12				

No	Description	Qty	Unit	Rate	Amount (KShs)
	ELEMENT No.2: SUPERSTRUCTURES				
A	Damp Proof Course 200mm wide bituminous felt as damp proof course and including 200mm laps	7.2	LM		
	Masonry Works -Superstructures Machine cut natural stone / concrete block wall; load bearing 7.0 N/mm ² ; bedded and jointed in cement and sand (1:4) mortar reinforced with 25mm x 20mm gauge hoop iron at every alternate course as described in;				
B	200mm thick walling	18	SM		
	Concrete Beam Insitu concrete class 25/20 , vibrated and reinforced as described, in	2	CM		
C	200 x200mm beam				
	High tensile steel reinforcement to B.S. 4449:2005 in structural concrete work including cutting, bending, hoisting, fixing, tying wire and spacing blocks in beam				
D	T10 (main bars - 4No)	18	KG		
	T8 (binders @200c/c)	10	KG		
	Pallisade walling <u>Mild steel pallisade walling in:-</u>				
E	40 x 40 x 1.2mm thick SHS vertical members securely fixed to ground slab at every coner and ends welding to roof rails (floor and roof height 2400mm) 6No.	15	LM		
F	40 x 40 x 1.2mm thick SHS horizontal members fixed to same size vertical member (m.s) by welding in 3 rows (top centre and bolttom as per the design	38	LM		
G	2100mm long 25 x 25 x 1.2mm thick SHS, vertical members fixed at 150 centre to centre including assembly and welding to horizontal members (ms) with an offset of 75mm from finished floor level	164	LM		
	Rain water goods				
H	Supply 140 mm U-shaped plastic gutters including necessary accessories such as brackets, end caps, and downspouts, and fix using appropriate fasteners.	7	LM		
J	75mm dia PVC downpipes	5	LM		
K	Ditto but 45° bend	4	No		
	Total carried to collection on page 7				

No	Description	Qty	Unit	Rate	Amount (KShs)
	Steel Door				
	<u>Fabricated to same matching design to pallisade walling:</u>				
A	2000mm wide double leaf steel door fabricated in 40x40x1.2mm thick SHS leaf vertical edge members (2100mm high) and 3 rows horizontal members and 25x25x1.2mm SHS 2100mm high vertical members at 150mm centre to centre synchronising in pattern to the pallisade wall and to the engineers details and including locking latch suitable for padlocking.	1	No		
	Framed Steel Roof Structure				
	Hollow section steel of various sizes cut to size with welded and/or bolted connections including hoisting and fixing and primed in grey oxide;				
B	40 x 40 x 1.2mm SHS rafters	12	LM		
C	Ditto beam over vertical members to support the roof	9	LM		
D	Ditto struts and ties	3	LM		
E	Ditto purlins	21	LM		
	Roof Covering				
F	28 Gauge box profile pre-painted sheet in roof covering 100 mm lap and 75 mm side laps screwed to purlins using self-drilling screws with rubber caps	21	SM		
G	28 gauge pre-painted ridge cap	7	LM		
	Painting Works				
	Prepare surfaces and apply one coat of approved primer and two finishing coats oil based/gloss paint to general surface of metal				
H	Roof and wall steel members not exceeding 50mm girth	342	LM		
	Concrete Ramp				
J	Allow for 2000mm wide concrete ramp at the entrance at a 10 degrees slope	1	ITEM		
	Total carried down to collection below				
	Collection:				
	Total brought forward from page 6				
	Total brought down from above				
	Total for SUPERSTRUCTURES carried to summary on page 12				

No	Description	Qty	Unit	Rate	Amount (KShs)
	ELEMENT No.3: FINISHES				
	WALL FINISHES				
	19mm thick cement and sand (1:4) gauged plaster on stone wall steel trowelled to:-				
A	Walls internally	20	SM		
B	Beam and walls above the beam externally	2	SM		
	Prepare and apply two undercoats and one finishing coat of plastic vinyl emulsion paint to:-				
C	Plastered walls internally and externally	22	SM		
	FLOOR FINISH:				
D	25mm thick cement screed to receive terrazzo finish	13	SM		
E	Terrazzo floor finish on screeded floor	13	SM		
	Total for FINISHES carried to summary on page 12				

No	Description	Qty	Unit	Rate	Amount (KShs)
	<p>ELEMENT No.4: ELECTRICAL INSTALLATION WORKS</p> <p>Note: The work under this element is to be carried out by a registered electrical subcontractor subject to the approval</p> <p>Supply, install test and commission in accordance to BS 7671:1998, the following as described below:</p> <p>LIGHTING INSTALLATION</p> <p>Lighting points wired in 3 x 1.5 sq.mm PVC insulated single core copper cable drawn in 20mm dia. PVC Heavy gauge conduit concealed in walls, for two way switching, where the total distance to between light and switch is 5 metres</p> <p>10A 240V wall mounted switch plates as legrand or equal and approved as described</p> <p>One gang one way</p> <p>Supply and install the following lighting fixtures complete with the control switchgears and lamp as per description and symbols:</p> <p>1x 2ft LED fluorescent fittings surface mounted as Power Technics Manufacture or equal and approved type 48</p> <p>SMALL POWER INSTALLATION</p> <p>Ring mains circuit power points wired in 3 x 2.5 sq.mm PVC insulated single core copper cable draw 20 mm heavy gauge conduits concealed in walls, total distance between the sockets is 10 metres</p> <p>240V white moulded socket plates as Legrand or equal and approved as described</p> <p>13A twin standard socket</p> <p>POWER DISTRIBUTION AND SUBMAINS INSTALLATION</p> <p>4 Ways 63A DP flush mounted consumer unit CCU</p> <p>MCBs for the items above</p> <p>10A SP for lighting</p> <p>30A SP for sockets</p>				
A		1	NO		
B		1	No		
C		1	No		
D		1	No		
E		1	No		
F		1	No		
G		1	No		
A		1	No		
B		1	No		
	Total carried to collection on page 10				

No	Description	Qty	Unit	Rate	Amount (KShs)
C	Blanking plates	2	No		
D	Provide material for cabling to consumer units from hospital DB 2.5mm sqd TWE in 20 mm h/g conduits running on the surface with saddle clips	50	LM		
E	Saddle clips 20 mm	20	Pcs		
Total carried down to collection below					
<p>Collection:</p> <p>Total brought forward from page 9</p> <p>Total brought down from above</p>					
Total for ELECTRICAL INSTALATION WORKS carried to summary on page 12					

No	Description	Qty	Unit	Rate	Amount (KShs)
A	<p>ELEMENT NO.5: PROVISIONAL SUMS</p> <p>Allow a Provisional sum of Kenya Twent Five Thousand (Kshs. 25,000/=) only for Contigencies</p>	1	ITEM		
	<p>Total for PROVISIONAL SUMS carried to summary on page 12</p>				

Summary Page

No	Description	Amount (KShs)
5	Total for SUBSTRUCURES brought forward from page 5	
5	Total for SUPERSTRUCTURES brought forward from page 7	
5	Total for FINISHES brought forward from page 8	
5	Total for ELECTRICAL INSTALLATION WORKS brought forward from page 10	
5	Total for PROVISIONAL SUMS brought forward from page 11	
	Total for Bill 2 - MANIFOLD SHED carried to Facility Summary on Page 14	

No	Description	Qty	Unit	Rate	Amount (KShs)
<u>BILL 3 - CYLINDER RACK</u>					
DETAILS AND DESCRIPTION - REFER TO THE DRAWING FOR MORE CLARIFICATIONS.					
1	RHS - 2X2 INCHES, 2 MM THICKNESS	30	LM		
2	DRILLING - DRILL MOUNTING HOLES AS PER THE DRAWING	12	No.		
3	FLAT BAR - 1-1/2" X1/4"	6	LM		
4	CHAIN - GRADE 30	8	LM		
5	RAWLBOLT - M-10	10	PCS		
6	PAINTWORKS - 2 COATS SPRAY PAINTING, BLACK COLOUR	1	LTRS		
7	TOP CAPS - HDPE TO COVER 2" SQUARE HOLLOW AS	12	PCS		
8	LABOUR - CONTINUOUS WELDING, MOUNTING		Item		
Total for Bill 3 - CYLINDER RACK carried to Facility Summary on Page 14					

FACILITY SUMMARY PAGE

No	Description	Quoted Amount	Required No.	Amount (KShs)
5	Total for Bill 1 - PIPING WORKS brought forward from page 2		1	
5	Total for Bill 2 - MANIFOLD SHED brought forward from page 12		1	
5	Total for Bill 3 - CYLINDER RACK brought forward from page 13		1	
Total for Health Facility carried to LOT SUMMARY Page				

No	Description	Qty	Unit	Rate	Amount (KShs)
<u>BILL 1 - PIPING WORKS</u>					
A	Distribution systems				
1.0	Manifold : Fully automatic Medical Oxygen Gas Manifold manufactured to ISO7396-1:2016 standards, complete with two stage regulator, monitoring alarm and hose connection ports with valves, with corresponding cylinders holding racks.				
	1(a) Wall mounted manifold (10x2)	0	No		
	1(b) Wall mounted manifold (8x2)	1	No		
	1(c) Wall mounted manifold (5x2)	0	No		
2.0	Cylinder connection steel braided pig tail hoses, Corresponding to item 1a or 1b or 1c above	16	No		
B	Copper pipes and fittings: Degreased copper pipes, manufactured from phosphorus de-oxidized non- arsenical copper to conform to ISO7396-1:2016 or BS EN13348:2016				
1.0	Pipes:				
	22mm diameter degreased copper pipes in metres	20	LM		
	15mm diameter degreased copper pipes in metres	80	LM		
	12mm diameter degreased copper pipes in metres	44	LM		
2.0	Elbows:				
	22mm diameter degreased copper elbows	2	Pcs		
	15mm diameter degreased copper elbows	20	Pcs		
3.0	Couplers:				
	22mm diameter degreased copper straight couplers	10	Pcs		
	15mm diameter degreased copper straight couplers	40	Pcs		
4.0	Reducers:				
	22x15mm diameter degreased copper reducer	10	Pcs		
	15x12mm diameter degreased copper reducer	29	Pcs		
5.0	Tees:				
	22mm diameter degreased copper equal Tees	10	Pcs		
	15mm diameter degreased copper equal Tees	29	Pcs		
C	Line ball valves c/w NIST,				
1.0	22mm medical gas line valves	1	Item		
2.0	15mm medical gas line valves	3	Item		
3.0	AVSU - 15mm oxygen area valve service unit complete with gauges	0	Item		
Total carried to collection on page 2					

MFL:15231 HF: Mother Francisca Mission Hospital

No	Description	Qty	Unit	Rate	Amount (KShs)
D	Medical Oxygen gas alarms				
1.0	Medical gas (oxygen only) monitoring alarm with % purity and pressure, with audio and visual display panels, conforming to ISO7396-1:2016	1	No		
E	Distribution Accessories				
1.0	22mm musen rings complete	2	No		
2.0	22mm plastic wall clamp	10	No		
3.0	15mm plastic wall clamp	40	No		
4.0	12mm plastic wall clamp	29	No		
5.0	M10 threaded rod	5	LM		
6.0	M10 hungers	20	No		
F	Oxygen terminal outlets, wall mount as per specifications IN THIS DOCUMENT	29	No		
G	1) Trunking for contingencies.	24	LM		
	2) Conduits for contingencies.	0	LM		
H	Provisional Sums - 50,000				
1.0	Allow for permanent and temporary identification of pipelines, valves.		Item		
2.0	PURGING: Allow for flushing the whole system with medical gases in accordance with ISO7396-1:2016 and to the satisfaction of the project Engineers. Purging is to be done using an inert gas such as Nitrogen.		Item		
3.0	TESTING AND COMMISSIONING: Allow for testing and commissioning of the entire medical gas pipeline system (using an inert gas such as Nitrogen), in accordance with the particular specification and to the satisfaction of the project Engineer, based on the (ISO7396-1:2016). The test such as pressure, leakage results duly recorded and clearly qualified in the commissioning report.		Item		
I	LABOUR COST		Item		
	Total carried to collection below				
	Collection:				
1.0	Total brought forward from page 1				
2.0	Total brought down from above				
	Total for Bill 1 - PIPING WORKS carried to Facility Summary on Page 14				

No	Description	Qty	Unit	Rate	Amount (KShs)
<u>BILL 2 - MANIFOLD SHED</u>					
ELEMENT No.1: SUBSTRUCTURES					
(ALL PROVISIONAL)					
EXCAVATION & FILLING					
Excavation					
A	Excavate 300mm deep to remove vegetable soil, load, wheel and deposit on site where directed.	24	SM		
B	Excavate to reduced levels 300mm (deep)	8	CM		
C	Excavate 60mm wide trench commencing from stripped level and not exceeding 600mm from reduced level	6	CM		
Plunking and Strutting					
D	Plunking and Strutting to sides of all excavations including keeping excavations free from all fallen materials	1	ITEM		
Disposal of water					
E	Allow for keeping excavations free from water all over	1	ITEM		
Fillings					
F	Return fill and compact selected excavated earthfilling in foundation to make up levels	3	CM		
Approved Murram/Red Soil Filling					
G	300mm thick approved murrum or red soil back filling; well rolled and compacted in 2 layers not exceeding 150mm deep to 96% compaction at optimum moisture content to bring up levels.	3	CM		
Approved Imported Filling					
H	300mm thick approved imported hardcore filling; well rolled and compacted in 2 layers not exceeding 150mm deep to 96% compaction at optimum moisture content	3	CM		
J	50mm thick quality murrum blinding on surfaces of hardcore	9	SM		
Disposal of Surplus Spoil:-					
K	Load and cart away surplus spoil from the site and deposit the same away from site where directed to approved dumping site	3	CM		
Total carried to collection on page 5					-

No	Description	Qty	Unit	Rate	Amount (KShs)
A	Anti-Termite Treatment Chemical anti-termite treatment to subsoil or filling: RENTOKIL. or equal approved: provide a ten year guarantee	9	SM		
B	Damp Proof Membrane 1000g Polythene damp proof membrane laid under floor bed with 300mm side and end lap (measured nett allow for laps)	13	SM		
SUBSTRUCTURE CONCRETE WORKS					
<u>Plain concrete class 15 (mix 1:3:6) as described, in:-</u>					
C	50mm thick surface blinding under strip footing and column bases	10	SM		
<u>In situ concrete class 25/20 , vibrated and reinforced as described, in:-</u>					
D	150mm thick strip footing	2	CM		
E	150mm thick floor slab	13	SM		
Reinforcement <u>High tensile steel reinforcement to B.S. 4449:2005 in structural concrete work including cutting, bending, hoisting, fixing, tying wire and spacing blocks in strip Footing</u>					
F	T10 (main bars)	30	KG		
G	T8 (binders)	20	KG		
<u>Mesh fabric reinforcement to B.S. 4483 and setting in concrete with 300mm side and end laps (measured nett-allow for laps)</u>					
H	Fabric mesh ref: A65 in floor bed	13	SM		
<u>Sawn formwork to:-</u>					
J	Ditto egdes of slabs, girth 75mm-150mm high	17	LM		
Masonry Works -Substructures <u>Load bearing natural stone walling, jointed in cement and sand (1:4) mortar with and including No. 20 gauge hoop iron ties 450mm long x 25mm wide bent and tacked into formwork with one end cast into concrete and straightened after removal of formwork and built into mortar joint of walling.</u>					
K	200mm thick wall in foundations	17	SM		
Total carried to collection on page 5					

No	Description	Qty	Unit	Rate	Amount (KShs)
	Plinth Finishing				
A	15mm thick cement, sand (1:4) render to plinth	5	SM		
B	Prepare and apply two undercoats and one finishing coat of first grade bituminous paint or equal approved on rendered plinth	5	SM		
	Total carried down to collection below				
	<u>Collection</u> Brought forward from page 3 Brought forward from page 4 Brought down from above				
	Total for SUBSTRUCTURES carried to summary on page 12				

No	Description	Qty	Unit	Rate	Amount (KShs)
	ELEMENT No.2: SUPERSTRUCTURES				
A	Damp Proof Course 200mm wide bituminous felt as damp proof course and including 200mm laps	7.2	LM		
	Masonry Works -Superstructures Machine cut natural stone / concrete block wall; load bearing 7.0 N/mm ² ; bedded and jointed in cement and sand (1:4) mortar reinforced with 25mm x 20mm gauge hoop iron at every alternate course as described in;				
B	200mm thick walling	18	SM		
	Concrete Beam Insitu concrete class 25/20 , vibrated and reinforced as described, in	2	CM		
C	200 x200mm beam				
	High tensile steel reinforcement to B.S. 4449:2005 in structural concrete work including cutting, bending, hoisting, fixing, tying wire and spacing blocks in beam				
D	T10 (main bars - 4No)	18	KG		
	T8 (binders @200c/c)	10	KG		
	Pallisade walling <u>Mild steel pallisade walling in:-</u>				
E	40 x 40 x 1.2mm thick SHS vertical members securely fixed to ground slab at every coner and ends welding to roof rails (floor and roof height 2400mm) 6No.	15	LM		
F	40 x 40 x 1.2mm thick SHS horizontal members fixed to same size vertical member (m.s) by welding in 3 rows (top centre and bolttom as per the design	38	LM		
G	2100mm long 25 x 25 x 1.2mm thick SHS, vertical members fixed at 150 centre to centre including assembly and welding to horizontal members (ms) with an offset of 75mm from finished floor level	164	LM		
	Rain water goods				
H	Supply 140 mm U-shaped plastic gutters including necessary accessories such as brackets, end caps, and downspouts, and fix using appropriate fasteners.	7	LM		
J	75mm dia PVC downpipes	5	LM		
K	Ditto but 45° bend	4	No		
	Total carried to collection on page 7				

No	Description	Qty	Unit	Rate	Amount (KShs)
	Steel Door				
	<u>Fabricated to same matching design to pallisade walling:</u>				
A	2000mm wide double leaf steel door fabricated in 40x40x1.2mm thick SHS leaf vertical edge members (2100mm high) and 3 rows horizontal members and 25x25x1.2mm SHS 2100mm high vertical members at 150mm centre to centre synchronising in pattern to the pallisade wall and to the engineers details and including locking latch suitable for padlocking.	1	No		
	Framed Steel Roof Structure				
	Hollow section steel of various sizes cut to size with welded and/or bolted connections including hoisting and fixing and primed in grey oxide;				
B	40 x 40 x 1.2mm SHS rafters	12	LM		
C	Ditto beam over vertical members to support the roof	9	LM		
D	Ditto struts and ties	3	LM		
E	Ditto purlins	21	LM		
	Roof Covering				
F	28 Gauge box profile pre-painted sheet in roof covering 100 mm lap and 75 mm side laps screwed to purlins using self-drilling screws with rubber caps	21	SM		
G	28 gauge pre-painted ridge cap	7	LM		
	Painting Works				
	Prepare surfaces and apply one coat of approved primer and two finishing coats oil based/gloss paint to general surface of metal				
H	Roof and wall steel members not exceeding 50mm girth	342	LM		
	Concrete Ramp				
J	Allow for 2000mm wide concrete ramp at the entrance at a 10 degrees slope	1	ITEM		
	Total carried down to collection below				
	Collection:				
	Total brought forward from page 6				
	Total brought down from above				
	Total for SUPERSTRUCTURES carried to summary on page 12				

No	Description	Qty	Unit	Rate	Amount (KShs)
	ELEMENT No.3: FINISHES				
	WALL FINISHES				
	19mm thick cement and sand (1:4) gauged plaster on stone wall steel trowelled to:-				
A	Walls internally	20	SM		
B	Beam and walls above the beam externally	2	SM		
	Prepare and apply two undercoats and one finishing coat of plastic vinyl emulsion paint to:-				
C	Plastered walls internally and externally	22	SM		
	FLOOR FINISH:				
D	25mm thick cement screed to receive terrazzo finish	13	SM		
E	Terrazzo floor finish on screeded floor	13	SM		
	Total for FINISHES carried to summary on page 12				

No	Description	Qty	Unit	Rate	Amount (KShs)
	<p>ELEMENT No.4: ELECTRICAL INSTALLATION WORKS</p> <p>Note: The work under this element is to be carried out by a registered electrical subcontractor subject to the approval</p> <p>Supply, install test and commission in accordance to BS 7671:1998, the following as described below:</p> <p>LIGHTING INSTALLATION</p> <p>Lighting points wired in 3 x 1.5 sq.mm PVC insulated single core copper cable drawn in 20mm dia. PVC Heavy gauge conduit concealed in walls, for two way switching, where the total distance to between light and switch is 5 metres</p> <p>10A 240V wall mounted switch plates as legrand or equal and approved as described</p> <p>One gang one way</p> <p>Supply and install the following lighting fixtures complete with the control switchgears and lamp as per description and symbols:</p> <p>1x 2ft LED fluorescent fittings surface mounted as Power Technics Manufacture or equal and approved type 48</p> <p>SMALL POWER INSTALLATION</p> <p>Ring mains circuit power points wired in 3 x 2.5 sq.mm PVC insulated single core copper cable draw 20 mm heavy gauge conduits concealed in walls, total distance between the sockets is 10 metres</p> <p>240V white moulded socket plates as Legrand or equal and approved as described</p> <p>13A twin standard socket</p> <p>POWER DISTRIBUTION AND SUBMAINS INSTALLATION</p> <p>4 Ways 63A DP flush mounted consumer unit CCU</p> <p>MCBs for the items above</p> <p>10A SP for lighting</p> <p>30A SP for sockets</p>				
A		1	NO		
B		1	No		
C		1	No		
D		1	No		
E		1	No		
F		1	No		
G		1	No		
A		1	No		
B		1	No		
	Total carried to collection on page 10				

No	Description	Qty	Unit	Rate	Amount (KShs)
C	Blanking plates	2	No		
D	Provide material for cabling to consumer units from hospital DB 2.5mm sqd TWE in 20 mm h/g conduits running on the surface with saddle clips	50	LM		
E	Saddle clips 20 mm	20	Pcs		
	Total carried down to collection below				
	<p>Collection:</p> <p>Total brought forward from page 9</p> <p>Total brought down from above</p>				
	Total for ELECTRICAL INSTALATION WORKS carried to summary on page 12				

No	Description	Qty	Unit	Rate	Amount (KShs)
A	<p>ELEMENT NO.5: PROVISIONAL SUMS</p> <p>Allow a Provisional sum of Kenya Twent Five Thousand (Kshs. 25,000/=) only for Contigencies</p>	1	ITEM		
	<p>Total for PROVISIONAL SUMS carried to summary on page 12</p>				

Summary Page

No	Description	Amount (KShs)
5	Total for SUBSTRUCURES brought forward from page 5	
5	Total for SUPERSTRUCTURES brought forward from page 7	
5	Total for FINISHES brought forward from page 8	
5	Total for ELECTRICAL INSTALLATION WORKS brought forward from page 10	
5	Total for PROVISIONAL SUMS brought forward from page 11	
	Total for Bill 2 - MANIFOLD SHED carried to Facility Summary on Page 14	

No	Description	Qty	Unit	Rate	Amount (KShs)
<u>BILL 3 - CYLINDER RACK</u>					
DETAILS AND DESCRIPTION - REFER TO THE DRAWING FOR MORE CLARIFICATIONS.					
1	RHS - 2X2 INCHES, 2 MM THICKNESS	30	LM		
2	DRILLING - DRILL MOUNTING HOLES AS PER THE DRAWING	12	No.		
3	FLAT BAR - 1-1/2" X1/4"	6	LM		
4	CHAIN - GRADE 30	8	LM		
5	RAWLBOLT - M-10	10	PCS		
6	PAINTWORKS - 2 COATS SPRAY PAINTING, BLACK COLOUR	1	LTRS		
7	TOP CAPS - HDPE TO COVER 2" SQUARE HOLLOW AS	12	PCS		
8	LABOUR - CONTINUOUS WELDING, MOUNTING		Item		
Total for Bill 3 - CYLINDER RACK carried to Facility Summary on Page 14					

FACILITY SUMMARY PAGE

No	Description	Quoted Amount	Required No.	Amount (KShs)
5	Total for Bill 1 - PIPING WORKS brought forward from page 2		1	
5	Total for Bill 2 - MANIFOLD SHED brought forward from page 12		1	
5	Total for Bill 3 - CYLINDER RACK brought forward from page 13		1	
Total for Health Facility carried to LOT SUMMARY Page				

No	Description	Qty	Unit	Rate	Amount (KShs)
<u>BILL 1 - PIPING WORKS</u>					
A	Distribution systems				
1.0	Manifold : Fully automatic Medical Oxygen Gas Manifold manufactured to ISO7396-1:2016 standards, complete with two stage regulator, monitoring alarm and hose connection ports with valves, with corresponding cylinders holding racks.				
	1(a) Wall mounted manifold (10x2)	0	No		
	1(b) Wall mounted manifold (8x2)	1	No		
	1(c) Wall mounted manifold (5x2)	0	No		
2.0	Cylinder connection steel braided pig tail hoses, Corresponding to item 1a or 1b or 1c above	16	No		
B	Copper pipes and fittings: Degreased copper pipes, manufactured from phosphorus de-oxidized non- arsenical copper to conform to ISO7396-1:2016 or BS EN13348:2016				
1.0	Pipes:				
	22mm diameter degreased copper pipes in metres	100	LM		
	15mm diameter degreased copper pipes in metres	150	LM		
	12mm diameter degreased copper pipes in metres	63	LM		
2.0	Elbows:				
	22mm diameter degreased copper elbows	10	Pcs		
	15mm diameter degreased copper elbows	38	Pcs		
3.0	Couplers:				
	22mm diameter degreased copper straight couplers	50	Pcs		
	15mm diameter degreased copper straight couplers	75	Pcs		
4.0	Reducers:				
	22x15mm diameter degreased copper reducer	10	Pcs		
	15x12mm diameter degreased copper reducer	42	Pcs		
5.0	Tees:				
	22mm diameter degreased copper equal Tees	10	Pcs		
	15mm diameter degreased copper equal Tees	42	Pcs		
C	Line ball valves c/w NIST,				
1.0	22mm medical gas line valves	4	Item		
2.0	15mm medical gas line valves	2	Item		
3.0	AVSU - 15mm oxygen area valve service unit complete with gauges	0	Item		
Total carried to collection on page 2					

**MFL:22839 HF: Our Lady of Mercy Mission Hospital
Nakuru**

No	Description	Qty	Unit	Rate	Amount (KShs)
D	Medical Oxygen gas alarms				
1.0	Medical gas (oxygen only) monitoring alarm with % purity and pressure, with audio and visual display panels, conforming to ISO7396-1:2016	1	No		
E	Distribution Accessories				
1.0	22mm musen rings complete	10	No		
2.0	22mm plastic wall clamp	50	No		
3.0	15mm plastic wall clamp	75	No		
4.0	12mm plastic wall clamp	42	No		
5.0	M10 threaded rod	5	LM		
6.0	M10 hungers	20	No		
F	Oxygen terminal outlets, wall mount as per specifications IN THIS DOCUMENT	42	No		
G	1) Trunking for contingencies.	0	LM		
	2) Conduits for contingencies.	0	LM		
H	Provisional Sums - 50,000				
1.0	Allow for permanent and temporary identification of pipelines, valves.		Item		
2.0	PURGING: Allow for flushing the whole system with medical gases in accordance with ISO7396-1:2016 and to the satisfaction of the project Engineers. Purging is to be done using an inert gas such as Nitrogen.		Item		
3.0	TESTING AND COMMISSIONING: Allow for testing and commissioning of the entire medical gas pipeline system (using an inert gas such as Nitrogen), in accordance with the particular specification and to the satisfaction of the project Engineer, based on the (ISO7396-1:2016). The test such as pressure, leakage results duly recorded and clearly qualified in the commissioning report.		Item		
I	LABOUR COST		Item		
	Total carried to collection below				
	Collection:				
1.0	Total brought forward from page 1				
2.0	Total brought down from above				
	Total for Bill 1 - PIPING WORKS carried to Facility Summary on Page 14				

No	Description	Qty	Unit	Rate	Amount (KShs)
	<u>BILL 2 - MANIFOLD SHED</u>				
	ELEMENT No.1: SUBSTRUCTURES				
	(ALL PROVISIONAL)				
	EXCAVATION & FILLING				
	Excavation				
A	Excavate 300mm deep to remove vegetable soil, load, wheel and deposit on site where directed.	24	SM		
B	Excavate to reduced levels 300mm (deep)	8	CM		
C	Excavate 60mm wide trench commencing from stripped level and not exceeding 600mm from reduced level	6	CM		
	Plunking and Strutting				
D	Plunking and Strutting to sides of all excavations including keeping excavations free from all fallen materials	1	ITEM		
	Disposal of water				
E	Allow for keeping excavations free from water all over	1	ITEM		
	Fillings				
F	Return fill and compact selected excavated earthfilling in foundation to make up levels	3	CM		
	Approved Murram/Red Soil Filling				
G	300mm thick approved murrum or red soil back filling; well rolled and compacted in 2 layers not exceeding 150mm deep to 96% compaction at optimum moisture content to bring up levels.	3	CM		
	Approved Imported Filling				
H	300mm thick approved imported hardcore filling; well rolled and compacted in 2 layers not exceeding 150mm deep to 96% compaction at optimum moisture content	3	CM		
J	50mm thick quality murrum blinding on surfaces of hardcore	9	SM		
	Disposal of Surplus Spoil:-				
K	Load and cart away surplus spoil from the site and deposit the same away from site where directed to approved dumping site	3	CM		
	Total carried to collection on page 5				-

No	Description	Qty	Unit	Rate	Amount (KShs)
A	Anti-Termite Treatment Chemical anti-termite treatment to subsoil or filling: RENTOKIL. or equal approved: provide a ten year guarantee	9	SM		
B	Damp Proof Membrane 1000g Polythene damp proof membrane laid under floor bed with 300mm side and end lap (measured nett allow for laps)	13	SM		
SUBSTRUCTURE CONCRETE WORKS					
<u>Plain concrete class 15 (mix 1:3:6) as described, in:-</u>					
C	50mm thick surface blinding under strip footing and column bases	10	SM		
<u>In situ concrete class 25/20 , vibrated and reinforced as described, in:-</u>					
D	150mm thick strip footing	2	CM		
E	150mm thick floor slab	13	SM		
Reinforcement <u>High tensile steel reinforcement to B.S. 4449:2005 in structural concrete work including cutting, bending, hoisting, fixing, tying wire and spacing blocks in strip Footing</u>					
F	T10 (main bars)	30	KG		
G	T8 (binders)	20	KG		
<u>Mesh fabric reinforcement to B.S. 4483 and setting in concrete with 300mm side and end laps (measured nett-allow for laps)</u>					
H	Fabric mesh ref: A65 in floor bed	13	SM		
<u>Sawn formwork to:-</u>					
J	Ditto egdes of slabs, girth 75mm-150mm high	17	LM		
Masonry Works -Substructures <u>Load bearing natural stone walling, jointed in cement and sand (1:4) mortar with and including No. 20 gauge hoop iron ties 450mm long x 25mm wide bent and tacked into formwork with one end cast into concrete and straightened after removal of formwork and built into mortar joint of walling.</u>					
K	200mm thick wall in foundations	17	SM		
Total carried to collection on page 5					

No	Description	Qty	Unit	Rate	Amount (KShs)
	Plinth Finishing				
A	15mm thick cement, sand (1:4) render to plinth	5	SM		
B	Prepare and apply two undercoats and one finishing coat of first grade bituminous paint or equal approved on rendered plinth	5	SM		
Total carried down to collection below					
	<u>Collection</u>				
	Brought forward from page 3				
	Brought forward from page 4				
	Brought down from above				
Total for SUBSTRUCTURES carried to summary on page 12					

No	Description	Qty	Unit	Rate	Amount (KShs)
	ELEMENT No.2: SUPERSTRUCTURES				
A	Damp Proof Course 200mm wide bituminous felt as damp proof course and including 200mm laps	7.2	LM		
	Masonry Works -Superstructures Machine cut natural stone / concrete block wall; load bearing 7.0 N/mm ² ; bedded and jointed in cement and sand (1:4) mortar reinforced with 25mm x 20mm gauge hoop iron at every alternate course as described in;				
B	200mm thick walling	18	SM		
	Concrete Beam Insitu concrete class 25/20 , vibrated and reinforced as described, in	2	CM		
C	200 x200mm beam				
	High tensile steel reinforcement to B.S. 4449:2005 in structural concrete work including cutting, bending, hoisting, fixing, tying wire and spacing blocks in beam				
D	T10 (main bars - 4No)	18	KG		
	T8 (binders @200c/c)	10	KG		
	Pallisade walling <u>Mild steel pallisade walling in:-</u>				
E	40 x 40 x 1.2mm thick SHS vertical members securely fixed to ground slab at every coner and ends welding to roof rails (floor and roof height 2400mm) 6No.	15	LM		
F	40 x 40 x 1.2mm thick SHS horizontal members fixed to same size vertical member (m.s) by welding in 3 rows (top centre and bolttom as per the design	38	LM		
G	2100mm long 25 x 25 x 1.2mm thick SHS, vertical members fixed at 150 centre to centre including assembly and welding to horizontal members (ms) with an offset of 75mm from finished floor level	164	LM		
	Rain water goods				
H	Supply 140 mm U-shaped plastic gutters including necessary accessories such as brackets, end caps, and downspouts, and fix using appropriate fasteners.	7	LM		
J	75mm dia PVC downpipes	5	LM		
K	Ditto but 45° bend	4	No		
	Total carried to collection on page 7				

No	Description	Qty	Unit	Rate	Amount (KShs)
	Steel Door				
	<u>Fabricated to same matching design to pallisade walling:</u>				
A	2000mm wide double leaf steel door fabricated in 40x40x1.2mm thick SHS leaf vertical edge members (2100mm high) and 3 rows horizontal members and 25x25x1.2mm SHS 2100mm high vertical members at 150mm centre to centre synchronising in pattern to the pallisade wall and to the engineers details and including locking latch suitable for padlocking.	1	No		
	Framed Steel Roof Structure				
	Hollow section steel of various sizes cut to size with welded and/or bolted connections including hoisting and fixing and primed in grey oxide;				
B	40 x 40 x 1.2mm SHS rafters	12	LM		
C	Ditto beam over vertical members to support the roof	9	LM		
D	Ditto struts and ties	3	LM		
E	Ditto purlins	21	LM		
	Roof Covering				
F	28 Gauge box profile pre-painted sheet in roof covering 100 mm lap and 75 mm side laps screwed to purlins using self-drilling screws with rubber caps	21	SM		
G	28 gauge pre-painted ridge cap	7	LM		
	Painting Works				
	Prepare surfaces and apply one coat of approved primer and two finishing coats oil based/gloss paint to general surface of metal				
H	Roof and wall steel members not exceeding 50mm girth	342	LM		
	Concrete Ramp				
J	Allow for 2000mm wide concrete ramp at the entrance at a 10 degrees slope	1	ITEM		
	Total carried down to collection below				
	Collection:				
	Total brought forward from page 6				
	Total brought down from above				
	Total for SUPERSTRUCTURES carried to summary on page 12				

No	Description	Qty	Unit	Rate	Amount (KShs)
	ELEMENT No.3: FINISHES				
	WALL FINISHES				
	19mm thick cement and sand (1:4) gauged plaster on stone wall steel trowelled to:-				
A	Walls internally	20	SM		
B	Beam and walls above the beam externally	2	SM		
	Prepare and apply two undercoats and one finishing coat of plastic vinyl emulsion paint to:-				
C	Plastered walls internally and externally	22	SM		
	FLOOR FINISH:				
D	25mm thick cement screed to receive terrazzo finish	13	SM		
E	Terrazzo floor finish on screeded floor	13	SM		
	Total for FINISHES carried to summary on page 12				

No	Description	Qty	Unit	Rate	Amount (KShs)
	<p>ELEMENT No.4: ELECTRICAL INSTALLATION WORKS</p> <p>Note: The work under this element is to be carried out by a registered electrical subcontractor subject to the approval</p> <p>Supply, install test and commission in accordance to BS 7671:1998, the following as described below:</p> <p>LIGHTING INSTALLATION</p> <p>Lighting points wired in 3 x 1.5 sq.mm PVC insulated single core copper cable drawn in 20mm dia. PVC Heavy gauge conduit concealed in walls, for two way switching, where the total distance to between light and switch is 5 metres</p> <p>10A 240V wall mounted switch plates as legrand or equal and approved as described</p> <p>One gang one way</p> <p>Supply and install the following lighting fixtures complete with the control switchgears and lamp as per description and symbols:</p> <p>1x 2ft LED fluorescent fittings surface mounted as Power Technics Manufacture or equal and approved type 48</p> <p>SMALL POWER INSTALLATION</p> <p>Ring mains circuit power points wired in 3 x 2.5 sq.mm PVC insulated single core copper cable draw 20 mm heavy gauge conduits concealed in walls, total distance between the sockets is 10 metres</p> <p>240V white moulded socket plates as Legrand or equal and approved as described</p> <p>13A twin standard socket</p> <p>POWER DISTRIBUTION AND SUBMAINS INSTALLATION</p> <p>4 Ways 63A DP flush mounted consumer unit CCU</p> <p>MCBs for the items above</p> <p>10A SP for lighting</p> <p>30A SP for sockets</p>				
A		1	NO		
B		1	No		
C		1	No		
D		1	No		
E		1	No		
F		1	No		
G		1	No		
A		1	No		
B		1	No		
	Total carried to collection on page 10				

No	Description	Qty	Unit	Rate	Amount (KShs)
C	Blanking plates	2	No		
D	Provide material for cabling to consumer units from hospital DB 2.5mm sqd TWE in 20 mm h/g conduits running on the surface with saddle clips	50	LM		
E	Saddle clips 20 mm	20	Pcs		
	Total carried down to collection below				
	<p>Collection:</p> <p>Total brought forward from page 9</p> <p>Total brought down from above</p>				
	Total for ELECTRICAL INSTALATION WORKS carried to summary on page 12				

No	Description	Qty	Unit	Rate	Amount (KShs)
A	<p>ELEMENT NO.5: PROVISIONAL SUMS</p> <p>Allow a Provisional sum of Kenya Twent Five Thousand (Kshs. 25,000/=) only for Contigencies</p>	1	ITEM		
	<p>Total for PROVISIONAL SUMS carried to summary on page 12</p>				

Summary Page

No	Description	Amount (KShs)
5	Total for SUBSTRUCURES brought forward from page 5	
5	Total for SUPERSTRUCTURES brought forward from page 7	
5	Total for FINISHES brought forward from page 8	
5	Total for ELECTRICAL INSTALLATION WORKS brought forward from page 10	
5	Total for PROVISIONAL SUMS brought forward from page 11	
	Total for Bill 2 - MANIFOLD SHED carried to Facility Summary on Page 14	

No	Description	Qty	Unit	Rate	Amount (KShs)
<u>BILL 3 - CYLINDER RACK</u>					
DETAILS AND DESCRIPTION - REFER TO THE DRAWING FOR MORE CLARIFICATIONS.					
1	RHS - 2X2 INCHES, 2 MM THICKNESS	30	LM		
2	DRILLING - DRILL MOUNTING HOLES AS PER THE DRAWING	12	No.		
3	FLAT BAR - 1-1/2" X1/4"	6	LM		
4	CHAIN - GRADE 30	8	LM		
5	RAWLBOLT - M-10	10	PCS		
6	PAINTWORKS - 2 COATS SPRAY PAINTING, BLACK COLOUR	1	LTRS		
7	TOP CAPS - HDPE TO COVER 2" SQUARE HOLLOW AS	12	PCS		
8	LABOUR - CONTINUOUS WELDING, MOUNTING		Item		
Total for Bill 3 - CYLINDER RACK carried to Facility Summary on Page 14					

FACILITY SUMMARY PAGE

No	Description	Quoted Amount	Required No.	Amount (KShs)
5	Total for Bill 1 - PIPING WORKS brought forward from page 2		1	
5	Total for Bill 2 - MANIFOLD SHED brought forward from page 12		1	
5	Total for Bill 3 - CYLINDER RACK brought forward from page 13		1	
Total for Health Facility carried to LOT SUMMARY Page				

No	Description	Qty	Unit	Rate	Amount (KShs)
<u>BILL 1 - PIPING WORKS</u>					
A	Distribution systems				
1.0	Manifold : Fully automatic Medical Oxygen Gas Manifold manufactured to ISO7396-1:2016 standards, complete with two stage regulator, monitoring alarm and hose connection ports with valves, with corresponding cylinders holding racks.				
	1(a) Wall mounted manifold (10x2)	0	No		
	1(b) Wall mounted manifold (8x2)	1	No		
	1(c) Wall mounted manifold (5x2)	0	No		
2.0	Cylinder connection steel braided pig tail hoses, Corresponding to item 1a or 1b or 1c above	16	No		
B	Copper pipes and fittings: Degreased copper pipes, manufactured from phosphorus de-oxidized non- arsenical copper to conform to ISO7396-1:2016 or BS EN13348:2016				
1.0	Pipes:				
	22mm diameter degreased copper pipes in metres	120	LM		
	15mm diameter degreased copper pipes in metres	150	LM		
	12mm diameter degreased copper pipes in metres	59	LM		
2.0	Elbows:				
	22mm diameter degreased copper elbows	12	Pcs		
	15mm diameter degreased copper elbows	38	Pcs		
3.0	Couplers:				
	22mm diameter degreased copper straight couplers	60	Pcs		
	15mm diameter degreased copper straight couplers	75	Pcs		
4.0	Reducers:				
	22x15mm diameter degreased copper reducer	10	Pcs		
	15x12mm diameter degreased copper reducer	39	Pcs		
5.0	Tees:				
	22mm diameter degreased copper equal Tees	10	Pcs		
	15mm diameter degreased copper equal Tees	39	Pcs		
C	Line ball valves c/w NIST,				
1.0	22mm medical gas line valves	2	Item		
2.0	15mm medical gas line valves	2	Item		
3.0	AVSU - 15mm oxygen area valve service unit complete with gauges	1	Item		
Total carried to collection on page 2					

MFL:15464 HF: RCEA Plateau Mission Hospital

No	Description	Qty	Unit	Rate	Amount (KShs)
D	Medical Oxygen gas alarms				
1.0	Medical gas (oxygen only) monitoring alarm with % purity and pressure, with audio and visual display panels, conforming to ISO7396-1:2016	1	No		
E	Distribution Accessories				
1.0	22mm musen rings complete	12	No		
2.0	22mm plastic wall clamp	60	No		
3.0	15mm plastic wall clamp	75	No		
4.0	12mm plastic wall clamp	39	No		
5.0	M10 threaded rod	5	LM		
6.0	M10 hungers	20	No		
F	Oxygen terminal outlets, wall mount as per specifications IN THIS DOCUMENT	39	No		
G	1) Trunking for contingencies.	0	LM		
	2) Conduits for contingencies.	0	LM		
H	Provisional Sums - 50,000				
1.0	Allow for permanent and temporary identification of pipelines, valves.		Item		
2.0	PURGING: Allow for flushing the whole system with medical gases in accordance with ISO7396-1:2016 and to the satisfaction of the project Engineers. Purging is to be done using an inert gas such as Nitrogen.		Item		
3.0	TESTING AND COMMISSIONING: Allow for testing and commissioning of the entire medical gas pipeline system (using an inert gas such as Nitrogen), in accordance with the particular specification and to the satisfaction of the project Engineer, based on the (ISO7396-1:2016). The test such as pressure, leakage results duly recorded and clearly qualified in the commissioning report.		Item		
I	LABOUR COST		Item		
	Total carried to collection below				
	Collection:				
1.0	Total brought forward from page 1				
2.0	Total brought down from above				
	Total for Bill 1 - PIPING WORKS carried to Facility Summary on Page 14				

No	Description	Qty	Unit	Rate	Amount (KShs)
<u>BILL 2 - MANIFOLD SHED</u>					
ELEMENT No.1: SUBSTRUCTURES					
(ALL PROVISIONAL)					
EXCAVATION & FILLING					
Excavation					
A	Excavate 300mm deep to remove vegetable soil, load, wheel and deposit on site where directed.	24	SM		
B	Excavate to reduced levels 300mm (deep)	8	CM		
C	Excavate 60mm wide trench commencing from stripped level and not exceeding 600mm from reduced level	6	CM		
Plunking and Strutting					
D	Plunking and Strutting to sides of all excavations including keeping excavations free from all fallen materials	1	ITEM		
Disposal of water					
E	Allow for keeping excavations free from water all over	1	ITEM		
Fillings					
F	Return fill and compact selected excavated earthfilling in foundation to make up levels	3	CM		
Approved Murram/Red Soil Filling					
G	300mm thick approved murrum or red soil back filling; well rolled and compacted in 2 layers not exceeding 150mm deep to 96% compaction at optimum moisture content to bring up levels.	3	CM		
Approved Imported Filling					
H	300mm thick approved imported hardcore filling; well rolled and compacted in 2 layers not exceeding 150mm deep to 96% compaction at optimum moisture content	3	CM		
J	50mm thick quality murrum blinding on surfaces of hardcore	9	SM		
Disposal of Surplus Spoil:-					
K	Load and cart away surplus spoil from the site and deposit the same away from site where directed to approved dumping site	3	CM		
Total carried to collection on page 5					-

No	Description	Qty	Unit	Rate	Amount (KShs)
A	Anti-Termite Treatment Chemical anti-termite treatment to subsoil or filling: RENTOKIL. or equal approved: provide a ten year guarantee	9	SM		
B	Damp Proof Membrane 1000g Polythene damp proof membrane laid under floor bed with 300mm side and end lap (measured nett allow for laps)	13	SM		
SUBSTRUCTURE CONCRETE WORKS					
<u>Plain concrete class 15 (mix 1:3:6) as described, in:-</u>					
C	50mm thick surface blinding under strip footing and column bases	10	SM		
<u>In situ concrete class 25/20 , vibrated and reinforced as described, in:-</u>					
D	150mm thick strip footing	2	CM		
E	150mm thick floor slab	13	SM		
Reinforcement <u>High tensile steel reinforcement to B.S. 4449:2005 in structural concrete work including cutting, bending, hoisting, fixing, tying wire and spacing blocks in strip Footing</u>					
F	T10 (main bars)	30	KG		
G	T8 (binders)	20	KG		
<u>Mesh fabric reinforcement to B.S. 4483 and setting in concrete with 300mm side and end laps (measured nett-allow for laps)</u>					
H	Fabric mesh ref: A65 in floor bed	13	SM		
<u>Sawn formwork to:-</u>					
J	Ditto egdes of slabs, girth 75mm-150mm high	17	LM		
Masonry Works -Substructures <u>Load bearing natural stone walling, jointed in cement and sand (1:4) mortar with and including No. 20 gauge hoop iron ties 450mm long x 25mm wide bent and tacked into formwork with one end cast into concrete and straightened after removal of formwork and built into mortar joint of walling.</u>					
K	200mm thick wall in foundations	17	SM		
Total carried to collection on page 5					

No	Description	Qty	Unit	Rate	Amount (KShs)
	Plinth Finishing				
A	15mm thick cement, sand (1:4) render to plinth	5	SM		
B	Prepare and apply two undercoats and one finishing coat of first grade bituminous paint or equal approved on rendered plinth	5	SM		
	Total carried down to collection below				
	<p><u>Collection</u></p> <p>Brought forward from page 3</p> <p>Brought forward from page 4</p> <p>Brought down from above</p>				
	Total for SUBSTRUCTURES carried to summary on page 12				

No	Description	Qty	Unit	Rate	Amount (KShs)
	ELEMENT No.2: SUPERSTRUCTURES				
A	Damp Proof Course 200mm wide bituminous felt as damp proof course and including 200mm laps	7.2	LM		
	Masonry Works -Superstructures Machine cut natural stone / concrete block wall; load bearing 7.0 N/mm ² ; bedded and jointed in cement and sand (1:4) mortar reinforced with 25mm x 20mm gauge hoop iron at every alternate course as described in;				
B	200mm thick walling	18	SM		
	Concrete Beam Insitu concrete class 25/20 , vibrated and reinforced as described, in	2	CM		
C	200 x200mm beam				
	High tensile steel reinforcement to B.S. 4449:2005 in structural concrete work including cutting, bending, hoisting, fixing, tying wire and spacing blocks in beam				
D	T10 (main bars - 4No)	18	KG		
	T8 (binders @200c/c)	10	KG		
	Pallisade walling <u>Mild steel pallisade walling in:-</u>				
E	40 x 40 x 1.2mm thick SHS vertical members securely fixed to ground slab at every coner and ends welding to roof rails (floor and roof height 2400mm) 6No.	15	LM		
F	40 x 40 x 1.2mm thick SHS horizontal members fixed to same size vertical member (m.s) by welding in 3 rows (top centre and bolttom as per the design	38	LM		
G	2100mm long 25 x 25 x 1.2mm thick SHS, vertical members fixed at 150 centre to centre including assembly and welding to horizontal members (ms) with an offset of 75mm from finished floor level	164	LM		
	Rain water goods				
H	Supply 140 mm U-shaped plastic gutters including necessary accessories such as brackets, end caps, and downspouts, and fix using appropriate fasteners.	7	LM		
J	75mm dia PVC downpipes	5	LM		
K	Ditto but 45° bend	4	No		
	Total carried to collection on page 7				

No	Description	Qty	Unit	Rate	Amount (KShs)
	Steel Door				
	<u>Fabricated to same matching design to pallisade walling:</u>				
A	2000mm wide double leaf steel door fabricated in 40x40x1.2mm thick SHS leaf vertical edge members (2100mm high) and 3 rows horizontal members and 25x25x1.2mm SHS 2100mm high vertical members at 150mm centre to centre synchronising in pattern to the pallisade wall and to the engineers details and including locking latch suitable for padlocking.	1	No		
	Framed Steel Roof Structure				
	Hollow section steel of various sizes cut to size with welded and/or bolted connections including hoisting and fixing and primed in grey oxide;				
B	40 x 40 x 1.2mm SHS rafters	12	LM		
C	Ditto beam over vertical members to support the roof	9	LM		
D	Ditto struts and ties	3	LM		
E	Ditto purlins	21	LM		
	Roof Covering				
F	28 Gauge box profile pre-painted sheet in roof covering 100 mm lap and 75 mm side laps screwed to purlins using self-drilling screws with rubber caps	21	SM		
G	28 gauge pre-painted ridge cap	7	LM		
	Painting Works				
	Prepare surfaces and apply one coat of approved primer and two finishing coats oil based/gloss paint to general surface of metal				
H	Roof and wall steel members not exceeding 50mm girth	342	LM		
	Concrete Ramp				
J	Allow for 2000mm wide concrete ramp at the entrance at a 10 degrees slope	1	ITEM		
	Total carried down to collection below				
	Collection:				
	Total brought forward from page 6				
	Total brought down from above				
	Total for SUPERSTRUCTURES carried to summary on page 12				

No	Description	Qty	Unit	Rate	Amount (KShs)
	ELEMENT No.3: FINISHES				
	WALL FINISHES				
	19mm thick cement and sand (1:4) gauged plaster on stone wall steel trowelled to:-				
A	Walls internally	20	SM		
B	Beam and walls above the beam externally	2	SM		
	Prepare and apply two undercoats and one finishing coat of plastic vinyl emulsion paint to:-				
C	Plastered walls internally and externally	22	SM		
	FLOOR FINISH:				
D	25mm thick cement screed to receive terrazzo finish	13	SM		
E	Terrazzo floor finish on screeded floor	13	SM		
	Total for FINISHES carried to summary on page 12				

No	Description	Qty	Unit	Rate	Amount (KShs)
	<p>ELEMENT No.4: ELECTRICAL INSTALLATION WORKS</p> <p>Note: The work under this element is to be carried out by a registered electrical subcontractor subject to the approval</p> <p>Supply, install test and commission in accordance to BS 7671:1998, the following as described below:</p> <p>LIGHTING INSTALLATION</p> <p>Lighting points wired in 3 x 1.5 sq.mm PVC insulated single core copper cable drawn in 20mm dia. PVC Heavy gauge conduit concealed in walls, for two way switching, where the total distance to between light and switch is 5 metres</p> <p>10A 240V wall mounted switch plates as legrand or equal and approved as described</p> <p>One gang one way</p> <p>Supply and install the following lighting fixtures complete with the control switchgears and lamp as per description and symbols:</p> <p>1x 2ft LED fluorescent fittings surface mounted as Power Technics Manufacture or equal and approved type 48</p> <p>SMALL POWER INSTALLATION</p> <p>Ring mains circuit power points wired in 3 x 2.5 sq.mm PVC insulated single core copper cable draw 20 mm heavy gauge conduits concealed in walls, total distance between the sockets is 10 metres</p> <p>240V white moulded socket plates as Legrand or equal and approved as described</p> <p>13A twin standard socket</p> <p>POWER DISTRIBUTION AND SUBMAINS INSTALLATION</p> <p>4 Ways 63A DP flush mounted consumer unit CCU</p> <p>MCBs for the items above</p> <p>10A SP for lighting</p> <p>30A SP for sockets</p>				
A		1	NO		
B		1	No		
C		1	No		
D		1	No		
E		1	No		
F		1	No		
G		1	No		
A		1	No		
B		1	No		
	Total carried to collection on page 10				

No	Description	Qty	Unit	Rate	Amount (KShs)
C	Blanking plates	2	No		
D	Provide material for cabling to consumer units from hospital DB 2.5mm sqd TWE in 20 mm h/g conduits running on the surface with saddle clips	50	LM		
E	Saddle clips 20 mm	20	Pcs		
	Total carried down to collection below				
	<p>Collection:</p> <p>Total brought forward from page 9</p> <p>Total brought down from above</p>				
	Total for ELECTRICAL INSTALATION WORKS carried to summary on page 12				

No	Description	Qty	Unit	Rate	Amount (KShs)
A	<p>ELEMENT NO.5: PROVISIONAL SUMS</p> <p>Allow a Provisional sum of Kenya Twent Five Thousand (Kshs. 25,000/=) only for Contigencies</p>	1	ITEM		
	<p>Total for PROVISIONAL SUMS carried to summary on page 12</p>				

Summary Page

No	Description	Amount (KShs)
5	Total for SUBSTRUCURES brought forward from page 5	
5	Total for SUPERSTRUCTURES brought forward from page 7	
5	Total for FINISHES brought forward from page 8	
5	Total for ELECTRICAL INSTALLATION WORKS brought forward from page 10	
5	Total for PROVISIONAL SUMS brought forward from page 11	
	Total for Bill 2 - MANIFOLD SHED carried to Facility Summary on Page 14	

No	Description	Qty	Unit	Rate	Amount (KShs)
<u>BILL 3 - CYLINDER RACK</u>					
DETAILS AND DESCRIPTION - REFER TO THE DRAWING FOR MORE CLARIFICATIONS.					
1	RHS - 2X2 INCHES, 2 MM THICKNESS	30	LM		
2	DRILLING - DRILL MOUNTING HOLES AS PER THE DRAWING	12	No.		
3	FLAT BAR - 1-1/2" X1/4"	6	LM		
4	CHAIN - GRADE 30	8	LM		
5	RAWLBOLT - M-10	10	PCS		
6	PAINTWORKS - 2 COATS SPRAY PAINTING, BLACK COLOUR	1	LTRS		
7	TOP CAPS - HDPE TO COVER 2" SQUARE HOLLOW AS	12	PCS		
8	LABOUR - CONTINUOUS WELDING, MOUNTING		Item		
Total for Bill 3 - CYLINDER RACK carried to Facility Summary on Page 14					

FACILITY SUMMARY PAGE

No	Description	Quoted Amount	Required No.	Amount (KShs)
5	Total for Bill 1 - PIPING WORKS brought forward from page 2		1	
5	Total for Bill 2 - MANIFOLD SHED brought forward from page 12		1	
5	Total for Bill 3 - CYLINDER RACK brought forward from page 13		1	
Total for Health Facility carried to LOT SUMMARY Page				

No	Description	Qty	Unit	Rate	Amount (KShs)
<u>BILL 1 - PIPING WORKS</u>					
A	Distribution systems				
1.0	Manifold : Fully automatic Medical Oxygen Gas Manifold manufactured to ISO7396-1:2016 standards, complete with two stage regulator, monitoring alarm and hose connection ports with valves, with corresponding cylinders holding racks.				
	1(a) Wall mounted manifold (10x2)	0	No		
	1(b) Wall mounted manifold (8x2)	1	No		
	1(c) Wall mounted manifold (5x2)	0	No		
2.0	Cylinder connection steel braided pig tail hoses, Corresponding to item 1a or 1b or 1c above	16	No		
B	Copper pipes and fittings: Degreased copper pipes, manufactured from phosphorus de-oxidized non- arsenical copper to conform to ISO7396-1:2016 or BS EN13348:2016				
1.0	Pipes:				
	22mm diameter degreased copper pipes in metres	120	LM		
	15mm diameter degreased copper pipes in metres	50	LM		
	12mm diameter degreased copper pipes in metres	54	LM		
2.0	Elbows:				
	22mm diameter degreased copper elbows	12	Pcs		
	15mm diameter degreased copper elbows	13	Pcs		
3.0	Couplers:				
	22mm diameter degreased copper straight couplers	60	Pcs		
	15mm diameter degreased copper straight couplers	25	Pcs		
4.0	Reducers:				
	22x15mm diameter degreased copper reducer	10	Pcs		
	15x12mm diameter degreased copper reducer	36	Pcs		
5.0	Tees:				
	22mm diameter degreased copper equal Tees	10	Pcs		
	15mm diameter degreased copper equal Tees	36	Pcs		
C	Line ball valves c/w NIST,				
1.0	22mm medical gas line valves	1	Item		
2.0	15mm medical gas line valves	3	Item		
3.0	AVSU - 15mm oxygen area valve service unit complete with gauges	0	Item		
Total carried to collection on page 2					

MFL:24931 HF: St. John's Mission Hospital Sirende

No	Description	Qty	Unit	Rate	Amount (KShs)
D	Medical Oxygen gas alarms				
1.0	Medical gas (oxygen only) monitoring alarm with % purity and pressure, with audio and visual display panels, conforming to ISO7396-1:2016	1	No		
E	Distribution Accessories				
1.0	22mm musen rings complete	12	No		
2.0	22mm plastic wall clamp	60	No		
3.0	15mm plastic wall clamp	25	No		
4.0	12mm plastic wall clamp	36	No		
5.0	M10 threaded rod	0	LM		
6.0	M10 hungers	0	No		
F	Oxygen terminal outlets, wall mount as per specifications IN THIS DOCUMENT	36	No		
G	1) Trunking for contingencies.	0	LM		
	2) Conduits for contingencies.	0	LM		
H	Provisional Sums - 50,000				
1.0	Allow for permanent and temporary identification of pipelines, valves.		Item		
2.0	PURGING: Allow for flushing the whole system with medical gases in accordance with ISO7396-1:2016 and to the satisfaction of the project Engineers. Purging is to be done using an inert gas such as Nitrogen.		Item		
3.0	TESTING AND COMMISSIONING: Allow for testing and commissioning of the entire medical gas pipeline system (using an inert gas such as Nitrogen), in accordance with the particular specification and to the satisfaction of the project Engineer, based on the (ISO7396-1:2016). The test such as pressure, leakage results duly recorded and clearly qualified in the commissioning report.		Item		
I	LABOUR COST		Item		
	Total carried to collection below				
	Collection:				
1.0	Total brought forward from page 1				
2.0	Total brought down from above				
	Total for Bill 1 - PIPING WORKS carried to Facility Summary on Page 14				

No	Description	Qty	Unit	Rate	Amount (KShs)
<u>BILL 2 - MANIFOLD SHED</u>					
ELEMENT No.1: SUBSTRUCTURES					
(ALL PROVISIONAL)					
EXCAVATION & FILLING					
Excavation					
A	Excavate 300mm deep to remove vegetable soil, load, wheel and deposit on site where directed.	24	SM		
B	Excavate to reduced levels 300mm (deep)	8	CM		
C	Excavate 60mm wide trench commencing from stripped level and not exceeding 600mm from reduced level	6	CM		
Plunking and Strutting					
D	Plunking and Strutting to sides of all excavations including keeping excavations free from all fallen materials	1	ITEM		
Disposal of water					
E	Allow for keeping excavations free from water all over	1	ITEM		
Fillings					
F	Return fill and compact selected excavated earthfilling in foundation to make up levels	3	CM		
Approved Murram/Red Soil Filling					
G	300mm thick approved murrum or red soil back filling; well rolled and compacted in 2 layers not exceeding 150mm deep to 96% compaction at optimum moisture content to bring up levels.	3	CM		
Approved Imported Filling					
H	300mm thick approved imported hardcore filling; well rolled and compacted in 2 layers not exceeding 150mm deep to 96% compaction at optimum moisture content	3	CM		
J	50mm thick quality murrum blinding on surfaces of hardcore	9	SM		
Disposal of Surplus Spoil:-					
K	Load and cart away surplus spoil from the site and deposit the same away from site where directed to approved dumping site	3	CM		
Total carried to collection on page 5					-

No	Description	Qty	Unit	Rate	Amount (KShs)
A	Anti-Termite Treatment Chemical anti-termite treatment to subsoil or filling: RENTOKIL. or equal approved: provide a ten year guarantee	9	SM		
B	Damp Proof Membrane 1000g Polythene damp proof membrane laid under floor bed with 300mm side and end lap (measured nett allow for laps)	13	SM		
SUBSTRUCTURE CONCRETE WORKS					
<u>Plain concrete class 15 (mix 1:3:6) as described, in:-</u>					
C	50mm thick surface blinding under strip footing and column bases	10	SM		
<u>In situ concrete class 25/20 , vibrated and reinforced as described, in:-</u>					
D	150mm thick strip footing	2	CM		
E	150mm thick floor slab	13	SM		
Reinforcement <u>High tensile steel reinforcement to B.S. 4449:2005 in structural concrete work including cutting, bending, hoisting, fixing, tying wire and spacing blocks in strip Footing</u>					
F	T10 (main bars)	30	KG		
G	T8 (binders)	20	KG		
<u>Mesh fabric reinforcement to B.S. 4483 and setting in concrete with 300mm side and end laps (measured nett-allow for laps)</u>					
H	Fabric mesh ref: A65 in floor bed	13	SM		
<u>Sawn formwork to:-</u>					
J	Ditto egdes of slabs, girth 75mm-150mm high	17	LM		
Masonry Works -Substructures <u>Load bearing natural stone walling, jointed in cement and sand (1:4) mortar with and including No. 20 gauge hoop iron ties 450mm long x 25mm wide bent and tacked into formwork with one end cast into concrete and straightened after removal of formwork and built into mortar joint of walling.</u>					
K	200mm thick wall in foundations	17	SM		
Total carried to collection on page 5					

No	Description	Qty	Unit	Rate	Amount (KShs)
	Plinth Finishing				
A	15mm thick cement, sand (1:4) render to plinth	5	SM		
B	Prepare and apply two undercoats and one finishing coat of first grade bituminous paint or equal approved on rendered plinth	5	SM		
	Total carried down to collection below				
	<p><u>Collection</u></p> <p>Brought forward from page 3</p> <p>Brought forward from page 4</p> <p>Brought down from above</p>				
	Total for SUBSTRUCTURES carried to summary on page 12				

No	Description	Qty	Unit	Rate	Amount (KShs)
	ELEMENT No.2: SUPERSTRUCTURES				
A	Damp Proof Course 200mm wide bituminous felt as damp proof course and including 200mm laps	7.2	LM		
	Masonry Works -Superstructures Machine cut natural stone / concrete block wall; load bearing 7.0 N/mm ² ; bedded and jointed in cement and sand (1:4) mortar reinforced with 25mm x 20mm gauge hoop iron at every alternate course as described in;				
B	200mm thick walling	18	SM		
	Concrete Beam Insitu concrete class 25/20 , vibrated and reinforced as described, in	2	CM		
C	200 x200mm beam				
	High tensile steel reinforcement to B.S. 4449:2005 in structural concrete work including cutting, bending, hoisting, fixing, tying wire and spacing blocks in beam				
D	T10 (main bars - 4No)	18	KG		
	T8 (binders @200c/c)	10	KG		
	Pallisade walling <u>Mild steel pallisade walling in:-</u>				
E	40 x 40 x 1.2mm thick SHS vertical members securely fixed to ground slab at every coner and ends welding to roof rails (floor and roof height 2400mm) 6No.	15	LM		
F	40 x 40 x 1.2mm thick SHS horizontal members fixed to same size vertical member (m.s) by welding in 3 rows (top centre and bolttom as per the design	38	LM		
G	2100mm long 25 x 25 x 1.2mm thick SHS, vertical members fixed at 150 centre to centre including assembly and welding to horizontal members (ms) with an offset of 75mm from finished floor level	164	LM		
	Rain water goods				
H	Supply 140 mm U-shaped plastic gutters including necessary accessories such as brackets, end caps, and downspouts, and fix using appropriate fasteners.	7	LM		
J	75mm dia PVC downpipes	5	LM		
K	Ditto but 45° bend	4	No		
	Total carried to collection on page 7				

No	Description	Qty	Unit	Rate	Amount (KShs)
	Steel Door				
	<u>Fabricated to same matching design to pallisade walling:</u>				
A	2000mm wide double leaf steel door fabricated in 40x40x1.2mm thick SHS leaf vertical edge members (2100mm high) and 3 rows horizontal members and 25x25x1.2mm SHS 2100mm high vertical members at 150mm centre to centre synchronising in pattern to the pallisade wall and to the engineers details and including locking latch suitable for padlocking.	1	No		
	Framed Steel Roof Structure				
	Hollow section steel of various sizes cut to size with welded and/or bolted connections including hoisting and fixing and primed in grey oxide;				
B	40 x 40 x 1.2mm SHS rafters	12	LM		
C	Ditto beam over vertical members to support the roof	9	LM		
D	Ditto struts and ties	3	LM		
E	Ditto purlins	21	LM		
	Roof Covering				
F	28 Gauge box profile pre-painted sheet in roof covering 100 mm lap and 75 mm side laps screwed to purlins using self-drilling screws with rubber caps	21	SM		
G	28 gauge pre-painted ridge cap	7	LM		
	Painting Works				
	Prepare surfaces and apply one coat of approved primer and two finishing coats oil based/gloss paint to general surface of metal				
H	Roof and wall steel members not exceeding 50mm girth	342	LM		
	Concrete Ramp				
J	Allow for 2000mm wide concrete ramp at the entrance at a 10 degrees slope	1	ITEM		
	Total carried down to collection below				
	Collection:				
	Total brought forward from page 6				
	Total brought down from above				
	Total for SUPERSTRUCTURES carried to summary on page 12				

No	Description	Qty	Unit	Rate	Amount (KShs)
	ELEMENT No.3: FINISHES				
	WALL FINISHES				
	19mm thick cement and sand (1:4) gauged plaster on stone wall steel trowelled to:-				
A	Walls internally	20	SM		
B	Beam and walls above the beam externally	2	SM		
	Prepare and apply two undercoats and one finishing coat of plastic vinyl emulsion paint to:-				
C	Plastered walls internally and externally	22	SM		
	FLOOR FINISH:				
D	25mm thick cement screed to receive terrazzo finish	13	SM		
E	Terrazzo floor finish on screeded floor	13	SM		
	Total for FINISHES carried to summary on page 12				

No	Description	Qty	Unit	Rate	Amount (KShs)
	<p>ELEMENT No.4: ELECTRICAL INSTALLATION WORKS</p> <p>Note: The work under this element is to be carried out by a registered electrical subcontractor subject to the approval</p> <p>Supply, install test and commission in accordance to BS 7671:1998, the following as described below:</p> <p>LIGHTING INSTALLATION</p> <p>Lighting points wired in 3 x 1.5 sq.mm PVC insulated single core copper cable drawn in 20mm dia. PVC Heavy gauge conduit concealed in walls, for two way switching, where the total distance to between light and switch is 5 metres</p> <p>10A 240V wall mounted switch plates as legrand or equal and approved as described</p> <p>One gang one way</p> <p>Supply and install the following lighting fixtures complete with the control switchgears and lamp as per description and symbols:</p> <p>1x 2ft LED fluorescent fittings surface mounted as Power Technics Manufacture or equal and approved type 48</p> <p>SMALL POWER INSTALLATION</p> <p>Ring mains circuit power points wired in 3 x 2.5 sq.mm PVC insulated single core copper cable draw 20 mm heavy gauge conduits concealed in walls, total distance between the sockets is 10 metres</p> <p>240V white moulded socket plates as Legrand or equal and approved as described</p> <p>13A twin standard socket</p> <p>POWER DISTRIBUTION AND SUBMAINS INSTALLATION</p> <p>4 Ways 63A DP flush mounted consumer unit CCU</p> <p>MCBs for the items above</p> <p>10A SP for lighting</p> <p>30A SP for sockets</p>				
A		1	NO		
B		1	No		
C		1	No		
D		1	No		
E		1	No		
F		1	No		
G		1	No		
A		1	No		
B		1	No		
	Total carried to collection on page 10				

No	Description	Qty	Unit	Rate	Amount (KShs)
C	Blanking plates	2	No		
D	Provide material for cabling to consumer units from hospital DB 2.5mm sqd TWE in 20 mm h/g conduits running on the surface with saddle clips	50	LM		
E	Saddle clips 20 mm	20	Pcs		
Total carried down to collection below					
<p>Collection:</p> <p>Total brought forward from page 9</p> <p>Total brought down from above</p>					
Total for ELECTRICAL INSTALATION WORKS carried to summary on page 12					

No	Description	Qty	Unit	Rate	Amount (KShs)
A	<p>ELEMENT NO.5: PROVISIONAL SUMS</p> <p>Allow a Provisional sum of Kenya Twent Five Thousand (Kshs. 25,000/=) only for Contigencies</p>	1	ITEM		
	<p>Total for PROVISIONAL SUMS carried to summary on page 12</p>				

Summary Page

No	Description	Amount (KShs)
5	Total for SUBSTRUCURES brought forward from page 5	
5	Total for SUPERSTRUCTURES brought forward from page 7	
5	Total for FINISHES brought forward from page 8	
5	Total for ELECTRICAL INSTALLATION WORKS brought forward from page 10	
5	Total for PROVISIONAL SUMS brought forward from page 11	
	Total for Bill 2 - MANIFOLD SHED carried to Facility Summary on Page 14	

No	Description	Qty	Unit	Rate	Amount (KShs)
<u>BILL 3 - CYLINDER RACK</u>					
DETAILS AND DESCRIPTION - REFER TO THE DRAWING FOR MORE CLARIFICATIONS.					
1	RHS - 2X2 INCHES, 2 MM THICKNESS	30	LM		
2	DRILLING - DRILL MOUNTING HOLES AS PER THE DRAWING	12	No.		
3	FLAT BAR - 1-1/2" X1/4"	6	LM		
4	CHAIN - GRADE 30	8	LM		
5	RAWLBOLT - M-10	10	PCS		
6	PAINTWORKS - 2 COATS SPRAY PAINTING, BLACK COLOUR	1	LTRS		
7	TOP CAPS - HDPE TO COVER 2" SQUARE HOLLOW AS	12	PCS		
8	LABOUR - CONTINUOUS WELDING, MOUNTING		Item		
Total for Bill 3 - CYLINDER RACK carried to Facility Summary on Page 14					

FACILITY SUMMARY PAGE

No	Description	Quoted Amount	Required No.	Amount (KShs)
5	Total for Bill 1 - PIPING WORKS brought forward from page 2		1	
5	Total for Bill 2 - MANIFOLD SHED brought forward from page 12		1	
5	Total for Bill 3 - CYLINDER RACK brought forward from page 13		1	
Total for Health Facility carried to LOT SUMMARY Page				

No	Description	Qty	Unit	Rate	Amount (KShs)
<u>BILL 1 - PIPING WORKS</u>					
A	Distribution systems				
1.0	Manifold : Fully automatic Medical Oxygen Gas Manifold manufactured to ISO7396-1:2016 standards, complete with two stage regulator, monitoring alarm and hose connection ports with valves, with corresponding cylinders holding racks.				
	1(a) Wall mounted manifold (10x2)	0	No		
	1(b) Wall mounted manifold (8x2)	1	No		
	1(c) Wall mounted manifold (5x2)	0	No		
2.0	Cylinder connection steel braided pig tail hoses, Corresponding to item 1a or 1b or 1c above	16	No		
B	Copper pipes and fittings: Degreased copper pipes, manufactured from phosphorus de-oxidized non- arsenical copper to conform to ISO7396-1:2016 or BS EN13348:2016				
1.0	Pipes:				
	22mm diameter degreased copper pipes in metres	3	LM		
	15mm diameter degreased copper pipes in metres	300	LM		
	12mm diameter degreased copper pipes in metres	96	LM		
2.0	Elbows:				
	22mm diameter degreased copper elbows	1	Pcs		
	15mm diameter degreased copper elbows	75	Pcs		
3.0	Couplers:				
	22mm diameter degreased copper straight couplers	2	Pcs		
	15mm diameter degreased copper straight couplers	150	Pcs		
4.0	Reducers:				
	22x15mm diameter degreased copper reducer	10	Pcs		
	15x12mm diameter degreased copper reducer	64	Pcs		
5.0	Tees:				
	22mm diameter degreased copper equal Tees	10	Pcs		
	15mm diameter degreased copper equal Tees	64	Pcs		
C	Line ball valves c/w NIST,				
1.0	22mm medical gas line valves	3	Item		
2.0	15mm medical gas line valves	1	Item		
3.0	AVSU - 15mm oxygen area valve service unit complete with gauges	1	Item		
Total carried to collection on page 2					

MFL:15645 HF: St. Josephs Mission Hospital Kilgoris

No	Description	Qty	Unit	Rate	Amount (KShs)
D	Medical Oxygen gas alarms				
1.0	Medical gas (oxygen only) monitoring alarm with % purity and pressure, with audio and visual display panels, conforming to ISO7396-1:2016	1	No		
E	Distribution Accessories				
1.0	22mm musen rings complete	1	No		
2.0	22mm plastic wall clamp	2	No		
3.0	15mm plastic wall clamp	150	No		
4.0	12mm plastic wall clamp	64	No		
5.0	M10 threaded rod	5	LM		
6.0	M10 hungers	20	No		
F	Oxygen terminal outlets, wall mount as per specifications IN THIS DOCUMENT	64	No		
G	1) Trunking for contingencies.	0	LM		
	2) Conduits for contingencies.	0	LM		
H	Provisional Sums - 50,000				
1.0	Allow for permanent and temporary identification of pipelines, valves.		Item		
2.0	PURGING: Allow for flushing the whole system with medical gases in accordance with ISO7396-1:2016 and to the satisfaction of the project Engineers. Purging is to be done using an inert gas such as Nitrogen.		Item		
3.0	TESTING AND COMMISSIONING: Allow for testing and commissioning of the entire medical gas pipeline system (using an inert gas such as Nitrogen), in accordance with the particular specification and to the satisfaction of the project Engineer, based on the (ISO7396-1:2016). The test such as pressure, leakage results duly recorded and clearly qualified in the commissioning report.		Item		
I	LABOUR COST		Item		
	Total carried to collection below				
	Collection:				
1.0	Total brought forward from page 1				
2.0	Total brought down from above				
	Total for Bill 1 - PIPING WORKS carried to Facility Summary on Page 14				

No	Description	Qty	Unit	Rate	Amount (KShs)
<u>BILL 2 - MANIFOLD SHED</u>					
ELEMENT No.1: SUBSTRUCTURES					
(ALL PROVISIONAL)					
EXCAVATION & FILLING					
Excavation					
A	Excavate 300mm deep to remove vegetable soil, load, wheel and deposit on site where directed.	24	SM		
B	Excavate to reduced levels 300mm (deep)	8	CM		
C	Excavate 60mm wide trench commencing from stripped level and not exceeding 600mm from reduced level	6	CM		
Plunking and Strutting					
D	Plunking and Strutting to sides of all excavations including keeping excavations free from all fallen materials	1	ITEM		
Disposal of water					
E	Allow for keeping excavations free from water all over	1	ITEM		
Fillings					
F	Return fill and compact selected excavated earthfilling in foundation to make up levels	3	CM		
Approved Murram/Red Soil Filling					
G	300mm thick approved murrum or red soil back filling; well rolled and compacted in 2 layers not exceeding 150mm deep to 96% compaction at optimum moisture content to bring up levels.	3	CM		
Approved Imported Filling					
H	300mm thick approved imported hardcore filling; well rolled and compacted in 2 layers not exceeding 150mm deep to 96% compaction at optimum moisture content	3	CM		
J	50mm thick quality murrum blinding on surfaces of hardcore	9	SM		
Disposal of Surplus Spoil:-					
K	Load and cart away surplus spoil from the site and deposit the same away from site where directed to approved dumping site	3	CM		
Total carried to collection on page 5					-

No	Description	Qty	Unit	Rate	Amount (KShs)
A	Anti-Termite Treatment Chemical anti-termite treatment to subsoil or filling: RENTOKIL. or equal approved: provide a ten year guarantee	9	SM		
B	Damp Proof Membrane 1000g Polythene damp proof membrane laid under floor bed with 300mm side and end lap (measured nett allow for laps)	13	SM		
SUBSTRUCTURE CONCRETE WORKS					
<u>Plain concrete class 15 (mix 1:3:6) as described, in:-</u>					
C	50mm thick surface blinding under strip footing and column bases	10	SM		
<u>In situ concrete class 25/20 , vibrated and reinforced as described, in:-</u>					
D	150mm thick strip footing	2	CM		
E	150mm thick floor slab	13	SM		
Reinforcement <u>High tensile steel reinforcement to B.S. 4449:2005 in structural concrete work including cutting, bending, hoisting, fixing, tying wire and spacing blocks in strip Footing</u>					
F	T10 (main bars)	30	KG		
G	T8 (binders)	20	KG		
<u>Mesh fabric reinforcement to B.S. 4483 and setting in concrete with 300mm side and end laps (measured nett-allow for laps)</u>					
H	Fabric mesh ref: A65 in floor bed	13	SM		
<u>Sawn formwork to:-</u>					
J	Ditto egdes of slabs, girth 75mm-150mm high	17	LM		
Masonry Works -Substructures <u>Load bearing natural stone walling, jointed in cement and sand (1:4) mortar with and including No. 20 gauge hoop iron ties 450mm long x 25mm wide bent and tacked into formwork with one end cast into concrete and straightened after removal of formwork and built into mortar joint of walling.</u>					
K	200mm thick wall in foundations	17	SM		
Total carried to collection on page 5					

No	Description	Qty	Unit	Rate	Amount (KShs)
	Plinth Finishing				
A	15mm thick cement, sand (1:4) render to plinth	5	SM		
B	Prepare and apply two undercoats and one finishing coat of first grade bituminous paint or equal approved on rendered plinth	5	SM		
	Total carried down to collection below				
	<p><u>Collection</u></p> <p>Brought forward from page 3</p> <p>Brought forward from page 4</p> <p>Brought down from above</p>				
	Total for SUBSTRUCTURES carried to summary on page 12				

No	Description	Qty	Unit	Rate	Amount (KShs)
	ELEMENT No.2: SUPERSTRUCTURES				
A	Damp Proof Course 200mm wide bituminous felt as damp proof course and including 200mm laps	7.2	LM		
	Masonry Works -Superstructures Machine cut natural stone / concrete block wall; load bearing 7.0 N/mm ² ; bedded and jointed in cement and sand (1:4) mortar reinforced with 25mm x 20mm gauge hoop iron at every alternate course as described in;				
B	200mm thick walling	18	SM		
	Concrete Beam Insitu concrete class 25/20 , vibrated and reinforced as described, in	2	CM		
C	200 x200mm beam				
	High tensile steel reinforcement to B.S. 4449:2005 in structural concrete work including cutting, bending, hoisting, fixing, tying wire and spacing blocks in beam				
D	T10 (main bars - 4No)	18	KG		
	T8 (binders @200c/c)	10	KG		
	Pallisade walling <u>Mild steel pallisade walling in:-</u>				
E	40 x 40 x 1.2mm thick SHS vertical members securely fixed to ground slab at every coner and ends welding to roof rails (floor and roof height 2400mm) 6No.	15	LM		
F	40 x 40 x 1.2mm thick SHS horizontal members fixed to same size vertical member (m.s) by welding in 3 rows (top centre and bolttom as per the design	38	LM		
G	2100mm long 25 x 25 x 1.2mm thick SHS, vertical members fixed at 150 centre to centre including assembly and welding to horizontal members (ms) with an offset of 75mm from finished floor level	164	LM		
	Rain water goods				
H	Supply 140 mm U-shaped plastic gutters including necessary accessories such as brackets, end caps, and downspouts, and fix using appropriate fasteners.	7	LM		
J	75mm dia PVC downpipes	5	LM		
K	Ditto but 45° bend	4	No		
	Total carried to collection on page 7				

No	Description	Qty	Unit	Rate	Amount (KShs)
	Steel Door				
	<u>Fabricated to same matching design to pallisade walling:</u>				
A	2000mm wide double leaf steel door fabricated in 40x40x1.2mm thick SHS leaf vertical edge members (2100mm high) and 3 rows horizontal members and 25x25x1.2mm SHS 2100mm high vertical members at 150mm centre to centre synchronising in pattern to the pallisade wall and to the engineers details and including locking latch suitable for padlocking.	1	No		
	Framed Steel Roof Structure				
	Hollow section steel of various sizes cut to size with welded and/or bolted connections including hoisting and fixing and primed in grey oxide;				
B	40 x 40 x 1.2mm SHS rafters	12	LM		
C	Ditto beam over vertical members to support the roof	9	LM		
D	Ditto struts and ties	3	LM		
E	Ditto purlins	21	LM		
	Roof Covering				
F	28 Gauge box profile pre-painted sheet in roof covering 100 mm lap and 75 mm side laps screwed to purlins using self-drilling screws with rubber caps	21	SM		
G	28 gauge pre-painted ridge cap	7	LM		
	Painting Works				
	Prepare surfaces and apply one coat of approved primer and two finishing coats oil based/gloss paint to general surface of metal				
H	Roof and wall steel members not exceeding 50mm girth	342	LM		
	Concrete Ramp				
J	Allow for 2000mm wide concrete ramp at the entrance at a 10 degrees slope	1	ITEM		
	Total carried down to collection below				
	Collection:				
	Total brought forward from page 6				
	Total brought down from above				
	Total for SUPERSTRUCTURES carried to summary on page 12				

No	Description	Qty	Unit	Rate	Amount (KShs)
	ELEMENT No.3: FINISHES				
	WALL FINISHES				
	19mm thick cement and sand (1:4) gauged plaster on stone wall steel trowelled to:-				
A	Walls internally	20	SM		
B	Beam and walls above the beam externally	2	SM		
	Prepare and apply two undercoats and one finishing coat of plastic vinyl emulsion paint to:-				
C	Plastered walls internally and externally	22	SM		
	FLOOR FINISH:				
D	25mm thick cement screed to receive terrazzo finish	13	SM		
E	Terrazzo floor finish on screeded floor	13	SM		
	Total for FINISHES carried to summary on page 12				

No	Description	Qty	Unit	Rate	Amount (KShs)
	<p>ELEMENT No.4: ELECTRICAL INSTALLATION WORKS</p> <p>Note: The work under this element is to be carried out by a registered electrical subcontractor subject to the approval</p> <p>Supply, install test and commission in accordance to BS 7671:1998, the following as described below:</p> <p>LIGHTING INSTALLATION</p> <p>Lighting points wired in 3 x 1.5 sq.mm PVC insulated single core copper cable drawn in 20mm dia. PVC Heavy gauge conduit concealed in walls, for two way switching, where the total distance to between light and switch is 5 metres</p> <p>10A 240V wall mounted switch plates as legrand or equal and approved as described</p> <p>One gang one way</p> <p>Supply and install the following lighting fixtures complete with the control switchgears and lamp as per description and symbols:</p> <p>1x 2ft LED fluorescent fittings surface mounted as Power Technics Manufacture or equal and approved type 48</p> <p>SMALL POWER INSTALLATION</p> <p>Ring mains circuit power points wired in 3 x 2.5 sq.mm PVC insulated single core copper cable draw 20 mm heavy gauge conduits concealed in walls, total distance between the sockets is 10 metres</p> <p>240V white moulded socket plates as Legrand or equal and approved as described</p> <p>13A twin standard socket</p> <p>POWER DISTRIBUTION AND SUBMAINS INSTALLATION</p> <p>4 Ways 63A DP flush mounted consumer unit CCU</p> <p>MCBs for the items above</p> <p>10A SP for lighting</p> <p>30A SP for sockets</p>				
A		1	NO		
B		1	No		
C		1	No		
D		1	No		
E		1	No		
F		1	No		
G		1	No		
A		1	No		
B		1	No		
	Total carried to collection on page 10				

No	Description	Qty	Unit	Rate	Amount (KShs)
C	Blanking plates	2	No		
D	Provide material for cabling to consumer units from hospital DB 2.5mm sqd TWE in 20 mm h/g conduits running on the surface with saddle clips	50	LM		
E	Saddle clips 20 mm	20	Pcs		
Total carried down to collection below					
<p>Collection:</p> <p>Total brought forward from page 9</p> <p>Total brought down from above</p>					
Total for ELECTRICAL INSTALATION WORKS carried to summary on page 12					

No	Description	Qty	Unit	Rate	Amount (KShs)
A	<p>ELEMENT NO.5: PROVISIONAL SUMS</p> <p>Allow a Provisional sum of Kenya Twent Five Thousand (Kshs. 25,000/=) only for Contigencies</p>	1	ITEM		
	<p>Total for PROVISIONAL SUMS carried to summary on page 12</p>				

Summary Page

No	Description	Amount (KShs)
5	Total for SUBSTRUCURES brought forward from page 5	
5	Total for SUPERSTRUCTURES brought forward from page 7	
5	Total for FINISHES brought forward from page 8	
5	Total for ELECTRICAL INSTALLATION WORKS brought forward from page 10	
5	Total for PROVISIONAL SUMS brought forward from page 11	
	Total for Bill 2 - MANIFOLD SHED carried to Facility Summary on Page 14	

No	Description	Qty	Unit	Rate	Amount (KShs)
<u>BILL 3 - CYLINDER RACK</u>					
DETAILS AND DESCRIPTION - REFER TO THE DRAWING FOR MORE CLARIFICATIONS.					
1	RHS - 2X2 INCHES, 2 MM THICKNESS	30	LM		
2	DRILLING - DRILL MOUNTING HOLES AS PER THE DRAWING	12	No.		
3	FLAT BAR - 1-1/2" X1/4"	6	LM		
4	CHAIN - GRADE 30	8	LM		
5	RAWLBOLT - M-10	10	PCS		
6	PAINTWORKS - 2 COATS SPRAY PAINTING, BLACK COLOUR	1	LTRS		
7	TOP CAPS - HDPE TO COVER 2" SQUARE HOLLOW AS	12	PCS		
8	LABOUR - CONTINUOUS WELDING, MOUNTING		Item		
Total for Bill 3 - CYLINDER RACK carried to Facility Summary on Page 14					

FACILITY SUMMARY PAGE

No	Description	Quoted Amount	Required No.	Amount (KShs)
5	Total for Bill 1 - PIPING WORKS brought forward from page 2		1	
5	Total for Bill 2 - MANIFOLD SHED brought forward from page 12		1	
5	Total for Bill 3 - CYLINDER RACK brought forward from page 13		1	
Total for Health Facility carried to LOT SUMMARY Page				

LOT SUMMARY PAGE

No	Health Facility	Amount	
		Kshs	Cts
1	AIC Kalokol Health Centre		
2	Chesongoch Mission Hospital		
3	Chesta dispensary		
4	AIC Litein Mission Hospital		
5	Mercy Mission Hospital		
6	Mother Francisca Mision Hospital		
7	Our Lady of Mercy Mission Hospital Nakuru		
8	RCEA Plateau Mission Hospital		
9	St. John's Mission Hospital Sirende		
10	St. Joseph Mission Hospital Kilgoris		
	Total		
	Add 16% VAT		
	TOTAL FOR LOT 1 carried to Form of Tender		

Amount in words: _____

Tenders Name: _____

Sign & stamp _____ Date _____

Witness Name _____

Sign _____ Date _____



PROPOSED MANIFOLD SHED & CYLINDER RACK

DRAWINGS

G28 prepainted box profile roofing sheet with a matching ridge cap
 On 40x40x1.2mm purlins
 On 40x40 x1.2mm rafters braced with 40x40x1.2mm SHS struts and ties
 Roof pitched at 8 degrees.

2000wide
 byx2200mm
 m double
 door

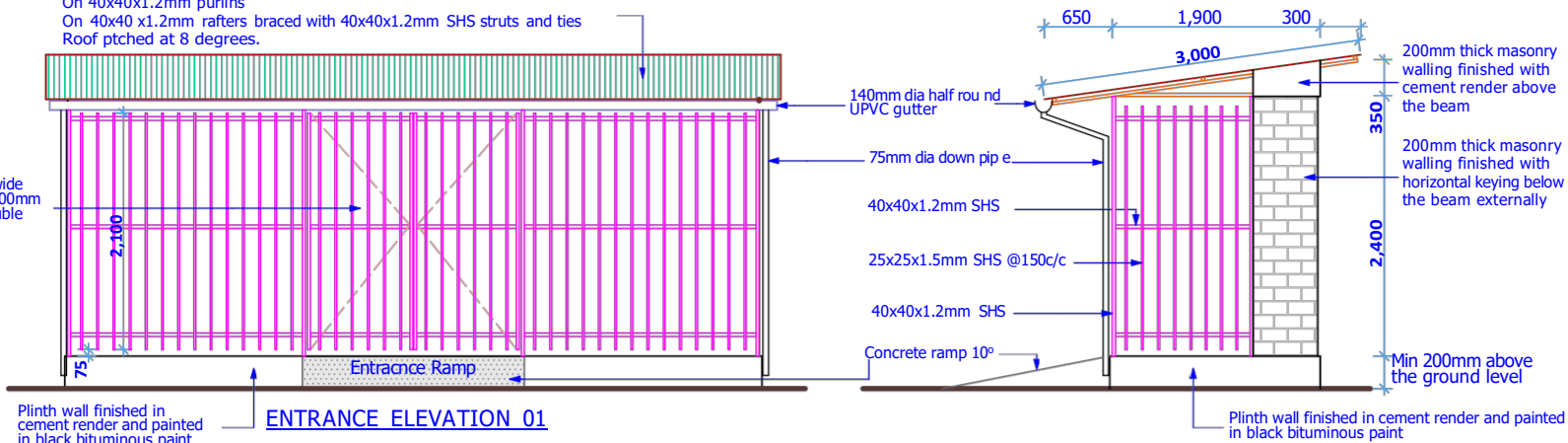

ENTRANCE ELEVATION 01

SIDE ELEVATION 02

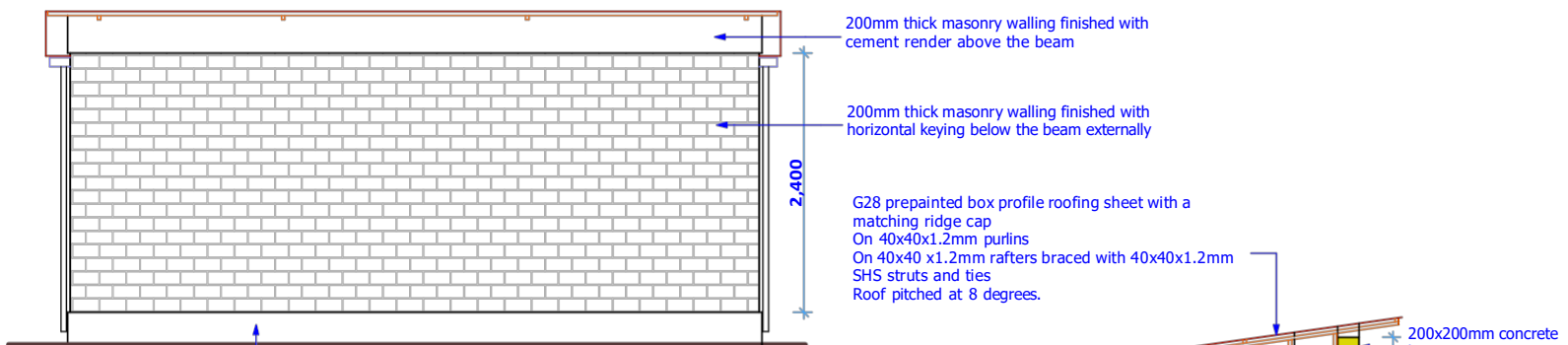

RARE ELEVATION 03

SECTION X-X

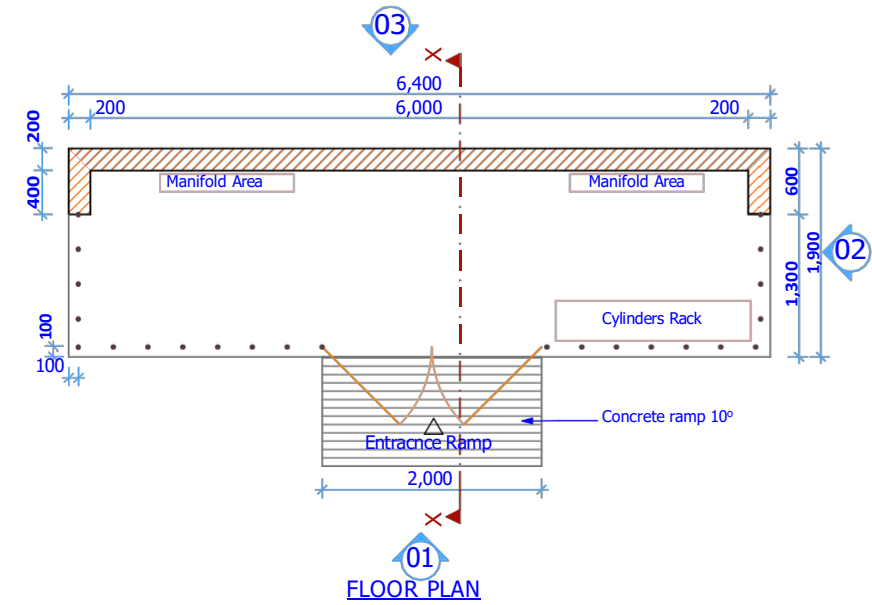

FLOOR PLAN

GENERAL NOTES

1. All dimension are in metric mm unless specified.
2. Dimensions to be read NOT scaled, only figured dimensions to be used.
3. Contractor to check and verify all dimensions on site before commencement of any works.
4. Any discrepancies to be reported to the project architect.
5. All works to be strictly in accordance with standard specifications and notes.
6. This drawing is to be read in conjunction with specification and all other relevant drawings.
7. Walls to be reinforced with hoop iron at every alternate courses.
8. Depth of the foundation to be determined on site.
9. PV denotes permanent air vents above doors and windows as shown on the drawing.
10. Drainage pipes passing under building to be encased in 150mm thick concrete surround.
11. All reinforced concrete works to Structural Engineers details.
12. All inspection chamber covers and framing shall be in compliance to approved standards.
13. All testing of pipes MUST be done before plastering.
14. All black cotton soil to be removed from below and around the building.
15. All soils under the building and around the external foundation to be treated with approved anti-termites treatment.

REVISION NOTES		
DATE	DESCRIPTION	REV BY

project:
PROPOSED TYPICAL MANIFOLD SHED DESIGN

location:
VARIOUS SITE.

organization:

**P. O. Box 30125 - 00100
 NAIROBI.**

drg title:
PLANS, ELEVATIONS & SECTION

stage:
WORKING DRAWING date: **JUNE, 2024**

designed & drawn by:
P. O signed: 

scale:
1 : 50mm

Oxygen Gas Cylinder Rack.

Materials; and dimensions;

1. Floor mountable oxygen gas cylinder barricade racks
2. **2 inch** square steel structural tubing (2 mm thick), 3 step framework, with continuous welding and exterior grade paint powder-coating (**A**);
3. High-density polyethylene (HDPE) top caps (**B**);
4. Grade 30, ASTM A413 steel support chains , 15 inches each, 20 pcs (**C**);
5. Floor mounting holes with 12 pre-drilled 0.5 inch dia. Location of 2 holes per frame (**D**).

Capacity:

Ten cylinders of two rows of 5 cylinders each see drawing Fig 1.

Overall Dimensions of the cage;

72"W x 26"D x 30"H: approximate weight 100 Kgs.

OSHA, NFP1, NFPA 55, and CGA regulation compliant

Fig 1.

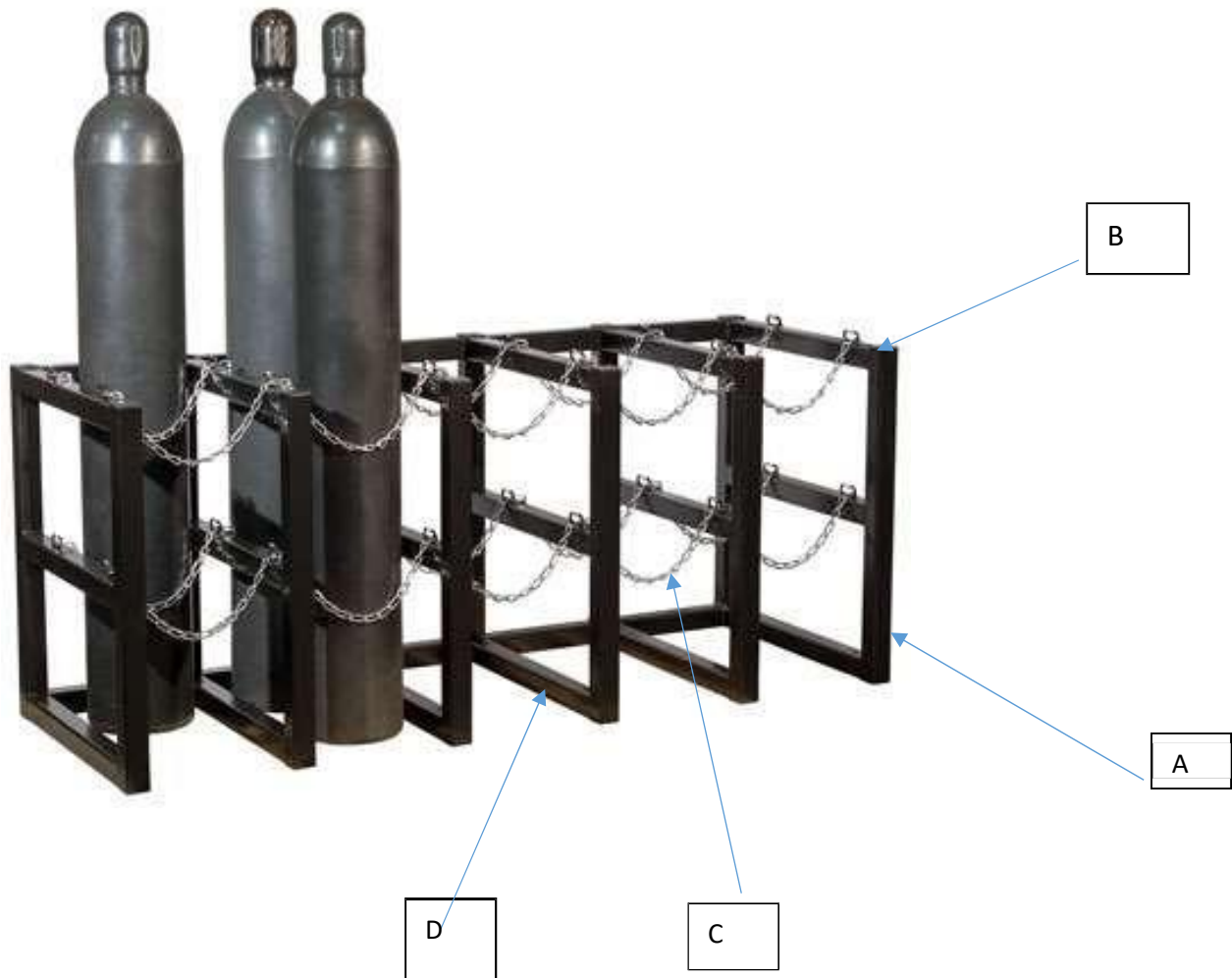



PIPING ROUTING AND FLOOR PLAN

©AUGUST 2024

Facility: Aic kalokol

PROPOSED PIPING ROUTE DRAWING FROM THE MANIFOLD TO THE POINT OF USE

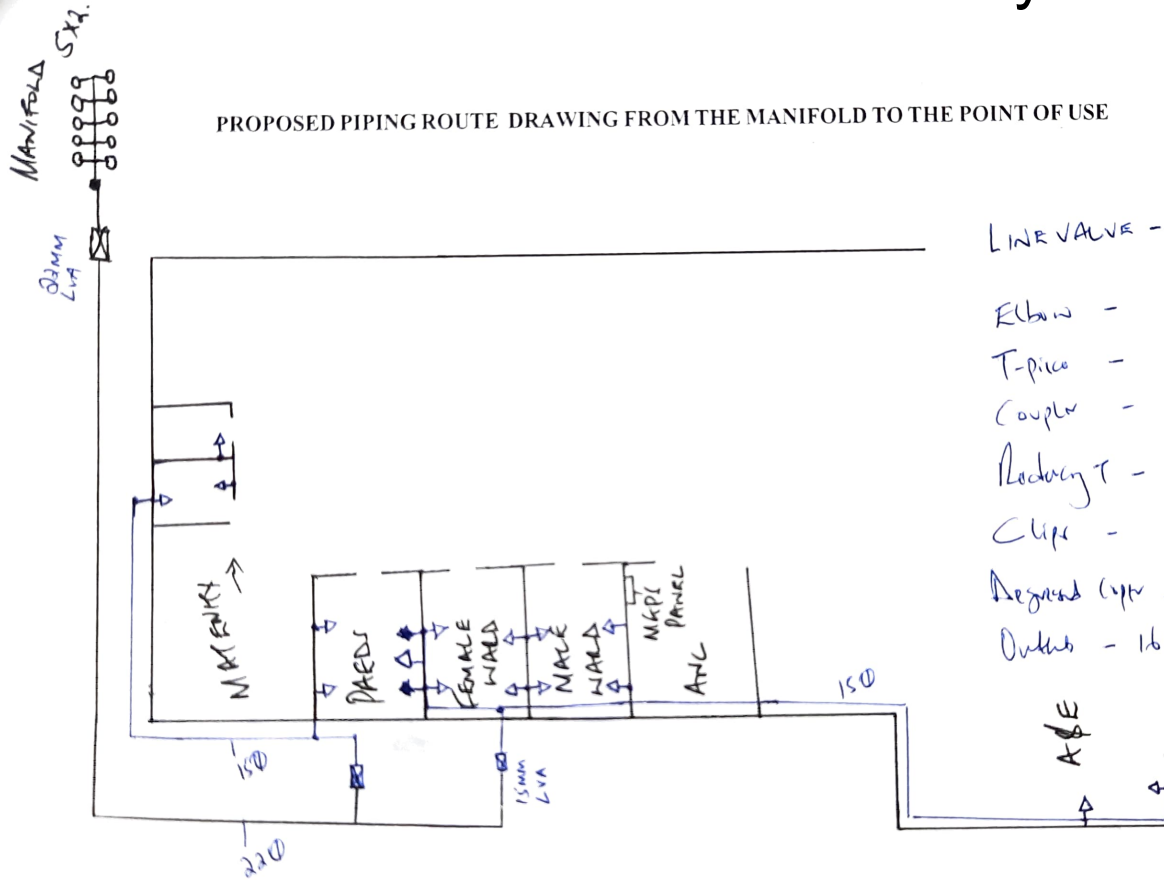

LINE VALVE -	22mm 1pc.	15mm 2pc.
Elbow -	10pc.	25pc.
T-piece -		13pc.
Coupler -	10pc.	30pc.
Reducy T -	4pc.	
Clips -	25pc.	77pc.
Segment Copter -	50m	154pc.
Outlets -	16pc.	

Proposed Drawing Approved By: (Name/ Designation / Date) 19/07/2024

Signature & Stamp

PROPOSED PIPING ROUTE DRAWING FROM THE MANIFOLD TO THE POINT OF USE

Survey done by
 1. Joseph Rugut - CBM
 2. Alexander Muposwe

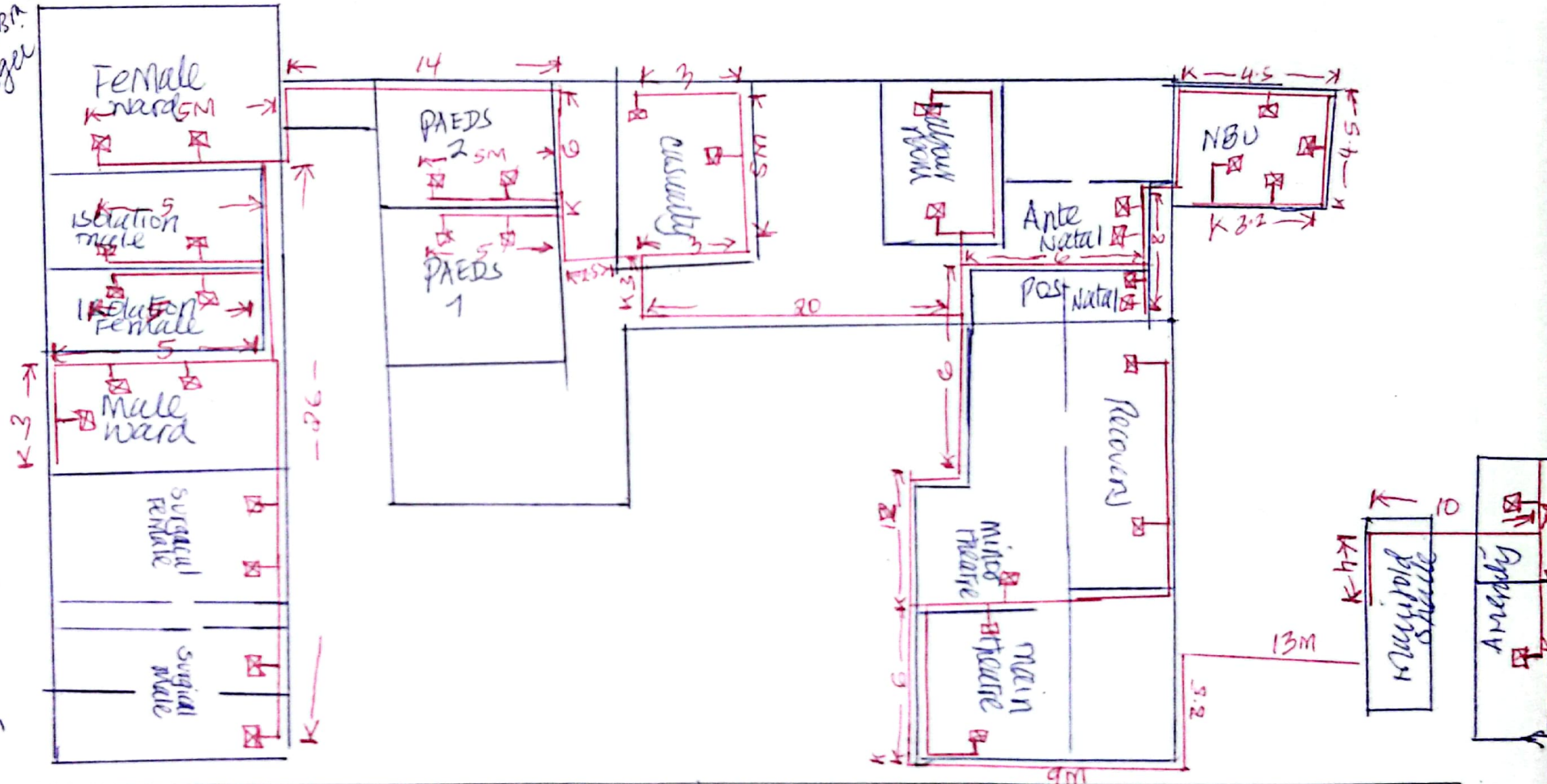

Manifold
 8x2 - 1pc
 Pipes
 22mm - 136m
 15mm - 100m
 12mm - 51m
 Outlet - 36pc

Proposed Drawing Approved By: (Name/ Designation / Date)

Dr. Liban Muti Raymond

Signature & Stamp

[Handwritten Signature]

**CHESONGOCH
 MISSION
 HOSPITAL**

CHESTA CLINIC - WEST POKOT COUNTY



PROPOSED PIPING ROUTE DRAWING FROM THE MANIFOLD TO THE POINT OF USE

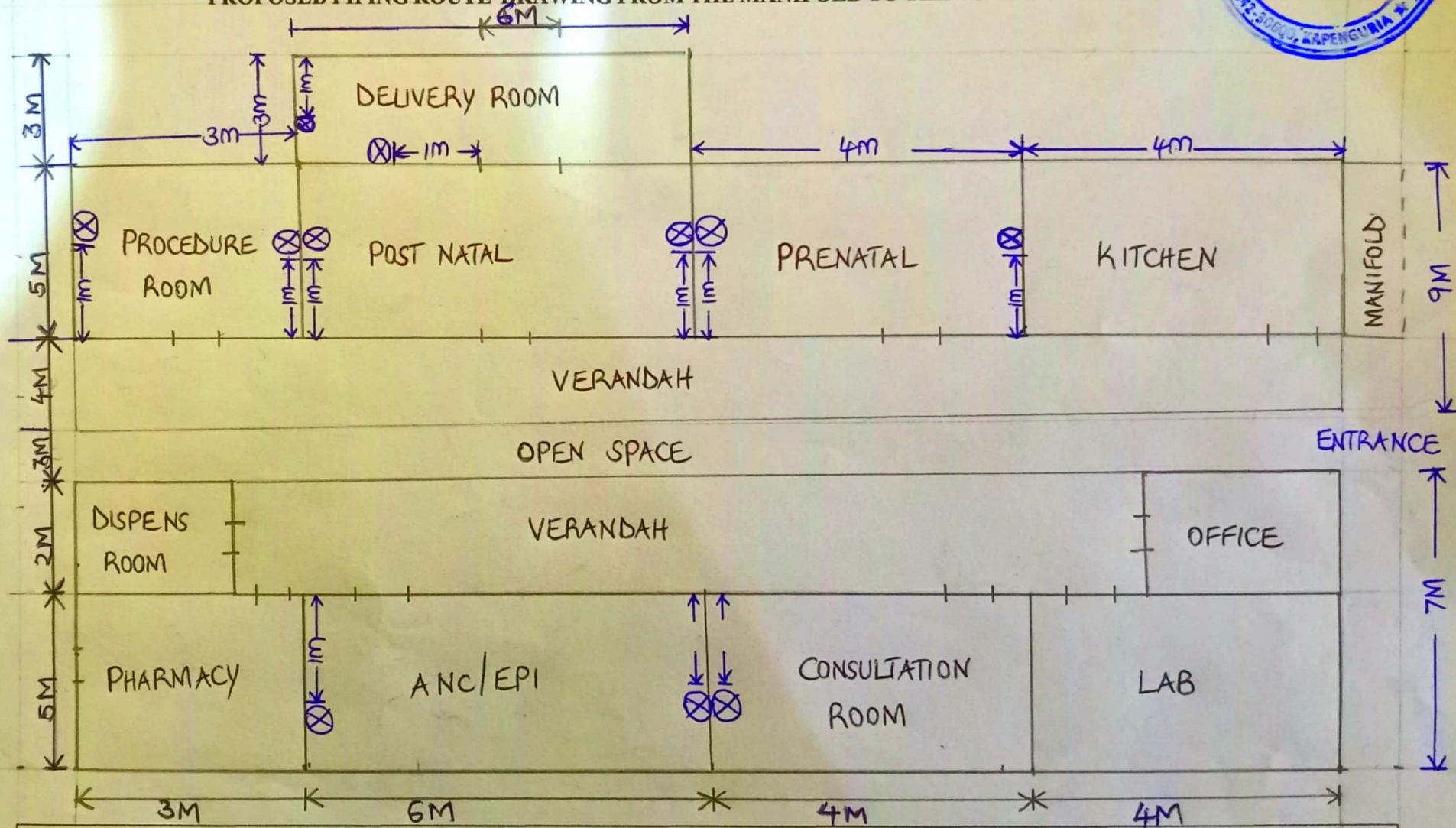

Proposed Drawing Approved By: (Name/ Designation / Date) _____

Signature & Stamp _____

MERCY MILSTON HOSPITAL - EL DANA RAVIN

PROPOSED PIPING ROUTE DRAWING FROM THE MANIFOLD TO THE POINT OF USE

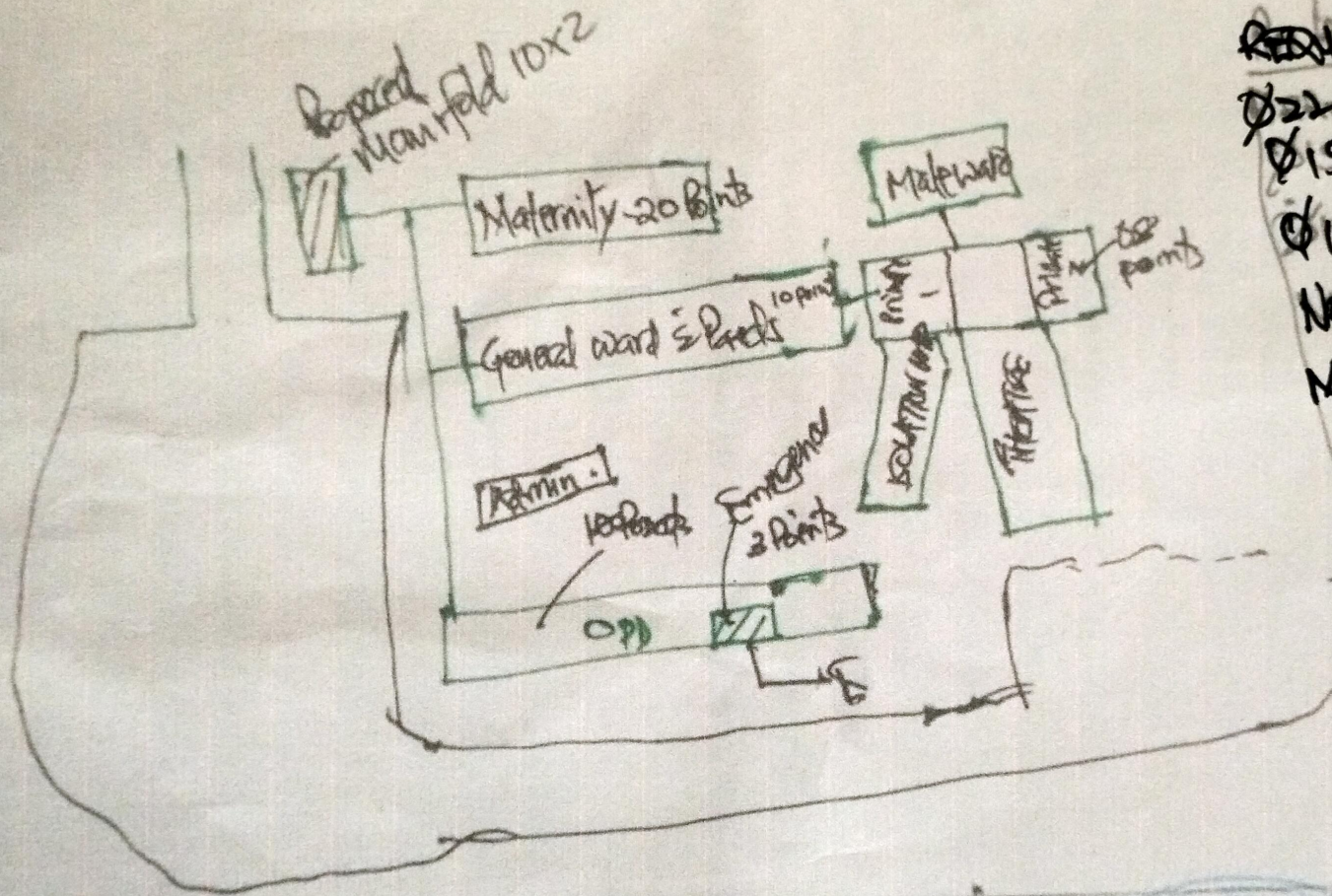

REQUIREMENTS
 $\phi 22mm = 283$
 $\phi 15 = 130$
 $\phi 12 = 180mm$
 No. outlets = 78
 Manifold 1x10x2 -
 AYSU - 2 No.
 Main Gate

Proposed Drawing Approved By (Name/ Designation / Date) **FR. FRANCIS NWAGO**
ADMINISTRATOR

Signature & Stamp *[Signature]*

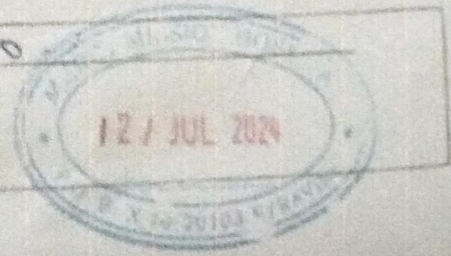

Facility: Mother Fransisca Mission Hospital

PROPOSED PIPING ROUTE DRAWING FROM THE MANIFOLD TO THE POINT OF USE

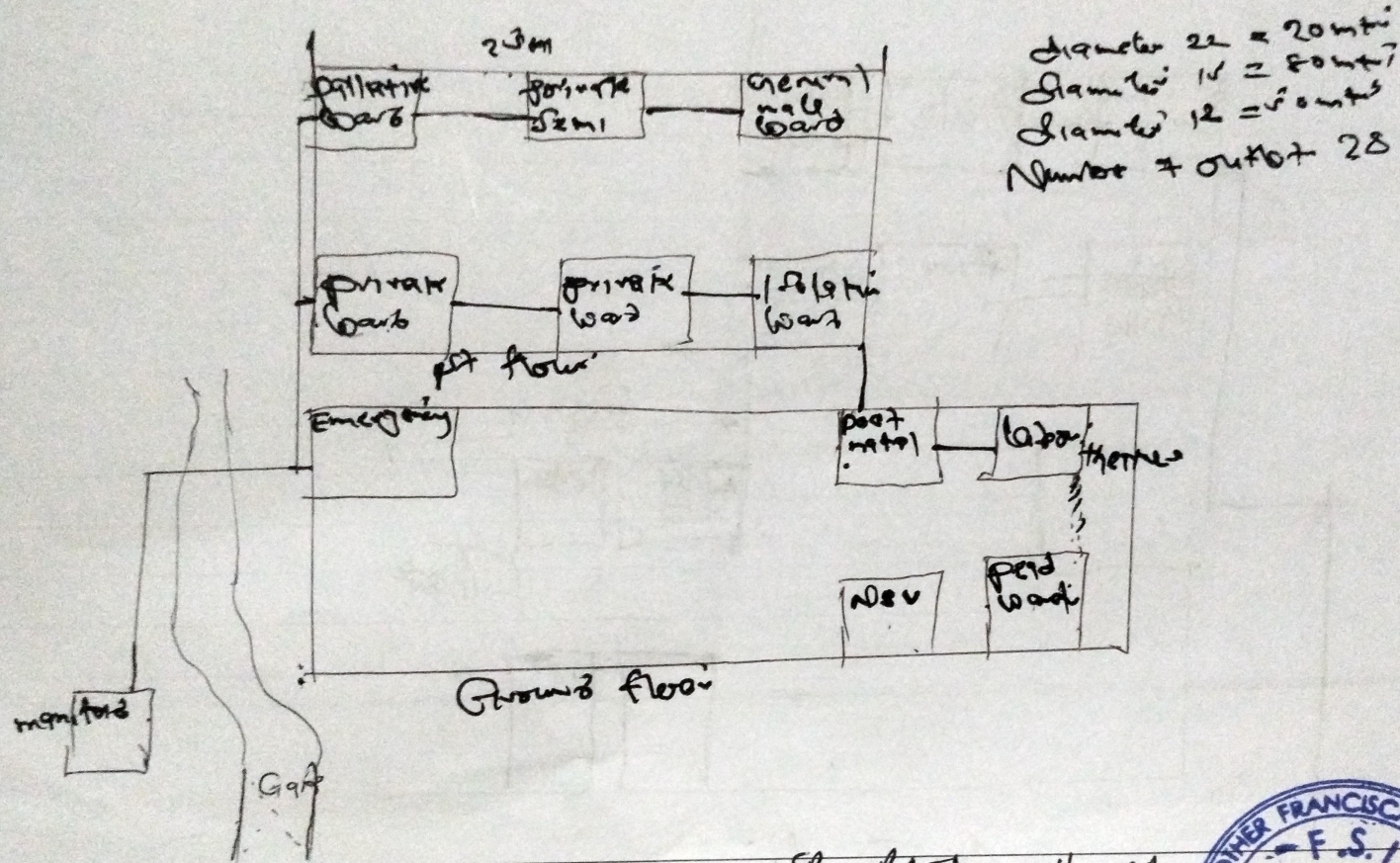

Proposed Drawing Approved By: (Name/ Designation / Date) SR RAEL CHUMBA

Signature & Stamp



PROPOSED PIPING LAYOUT DRAWING FROM THE MANIFOLD TO THE POINT OF USE

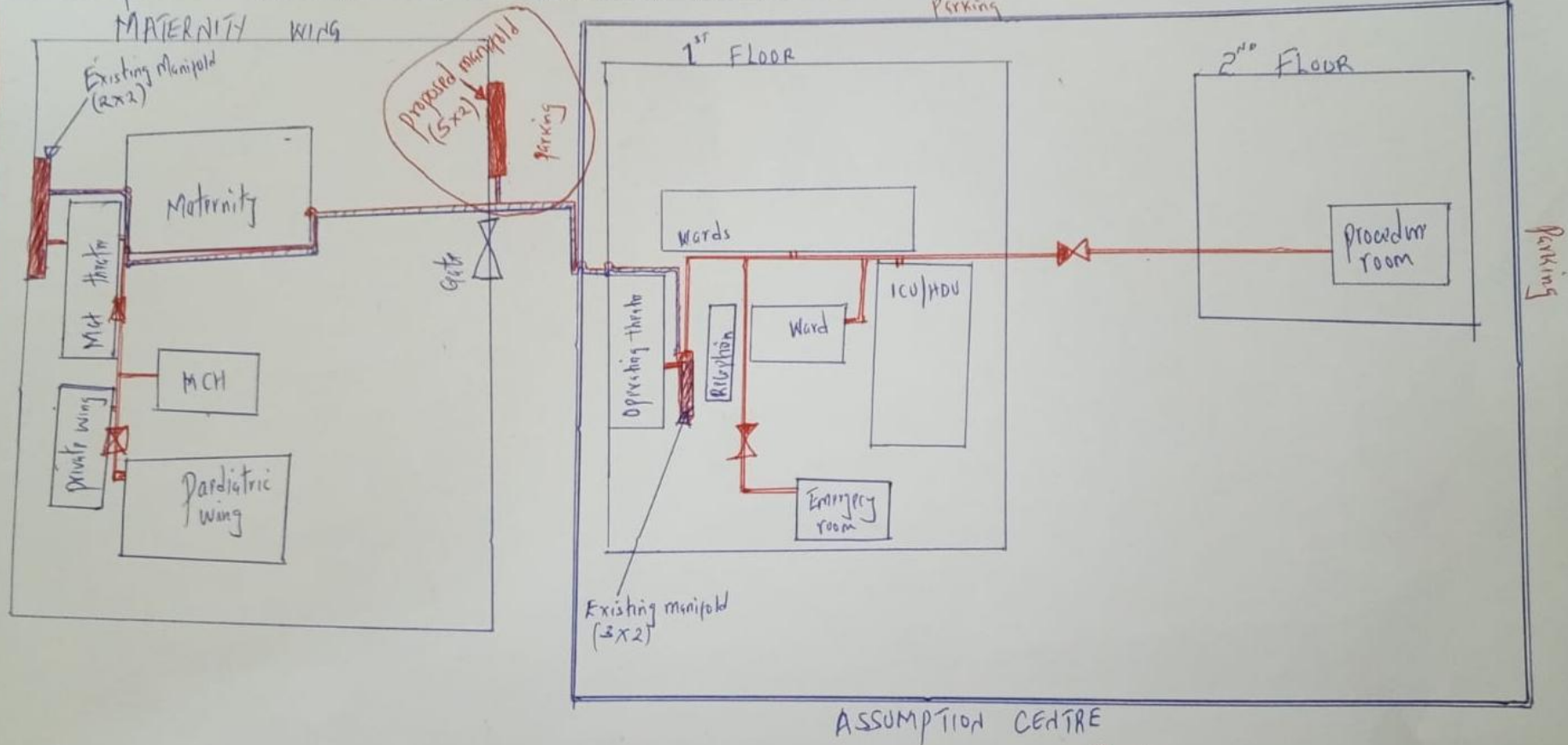

- i) Total O_2 outlets required 42
- ii) Shut off valve No. 7
- iii) No. AVSU 2

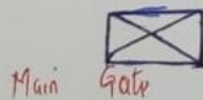

Signature & Stamp: *[Signature]*



- Degreased Copper pipes length
- i) \varnothing 22mm - 100m
 - ii) \varnothing 15mm - 150m
 - iii) \varnothing 12mm - 80m

OUR LADY OF MERCY MISSION HOSPITAL NAKURU

MERCY MILSTON HOSPITAL - EL DANA RAVIN

PROPOSED PIPING ROUTE DRAWING FROM THE MANIFOLD TO THE POINT OF USE

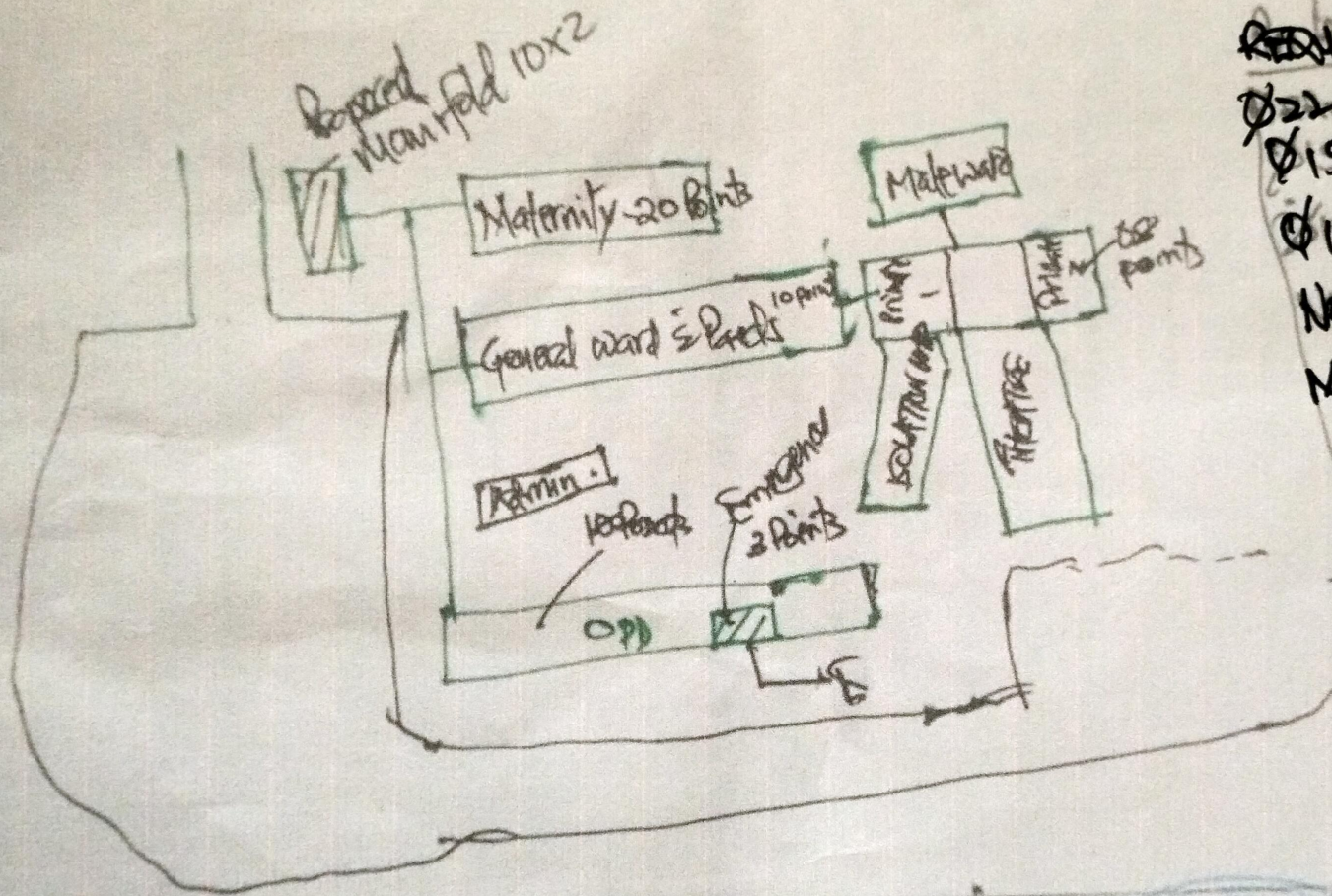

REQUIREMENTS
 $\phi 22m = 283$
 $\phi 15 = 130$
 $\phi 12 = 180m$
 No. outlets = 78
 Manifold 1x10x2 -
 AYSU - 2 No.
 Main Gate

Proposed Drawing Approved By (Name/ Designation / Date) **FR. FRANCIS NWAGO**
ADMINISTRATOR

Signature & Stamp 

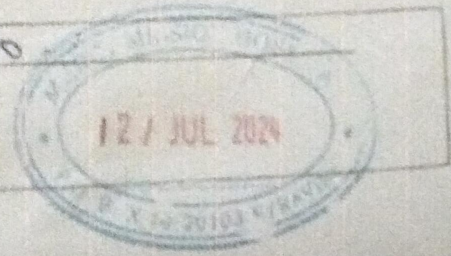

ST. JOSEPH'S MISSION HOSPITAL - KILIGORIS.

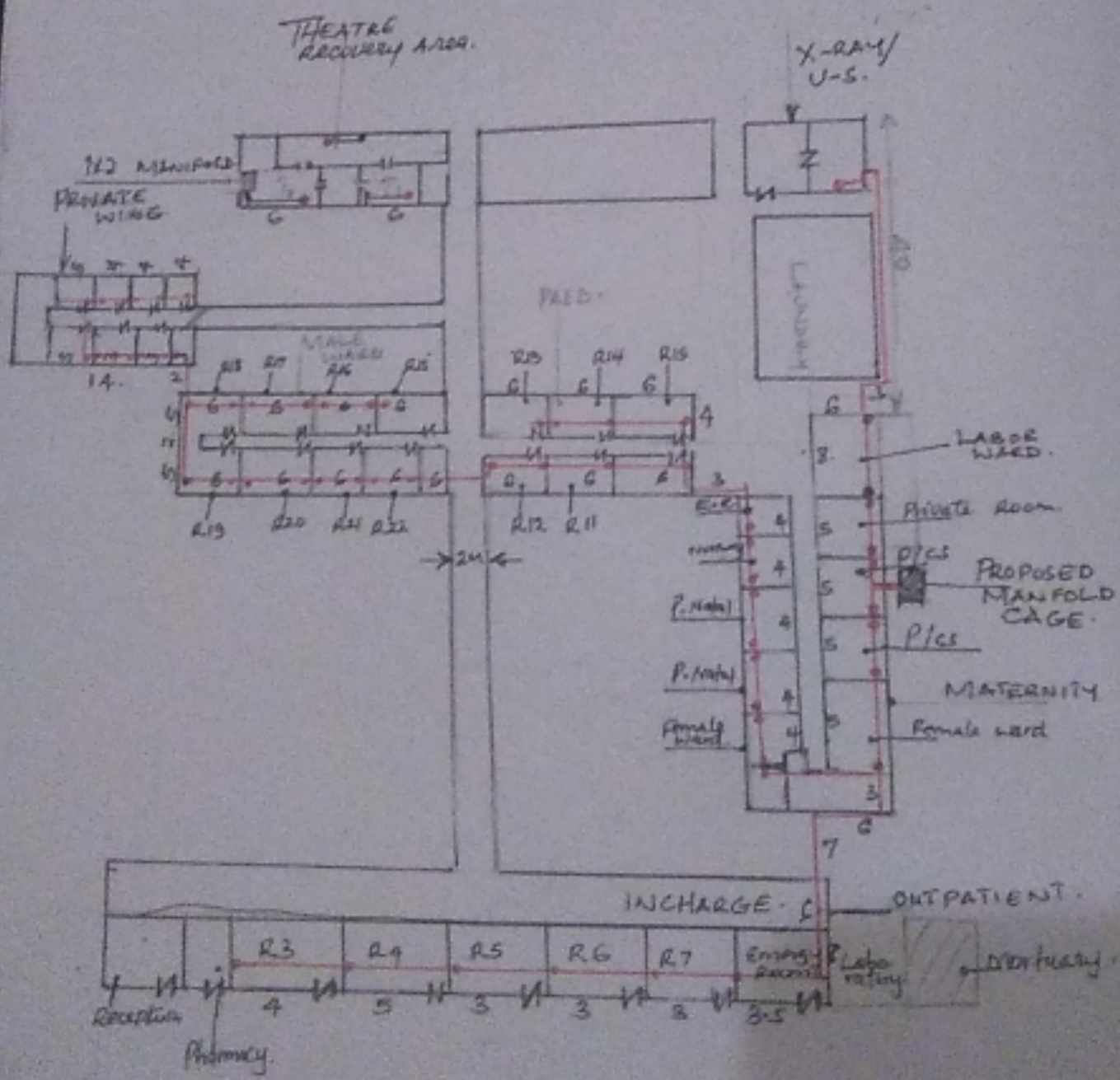

Facility: St. John's Sirende

PROPOSED PIPING ROUTE DRAWING FROM THE MANIFOLD TO THE POINT OF USE

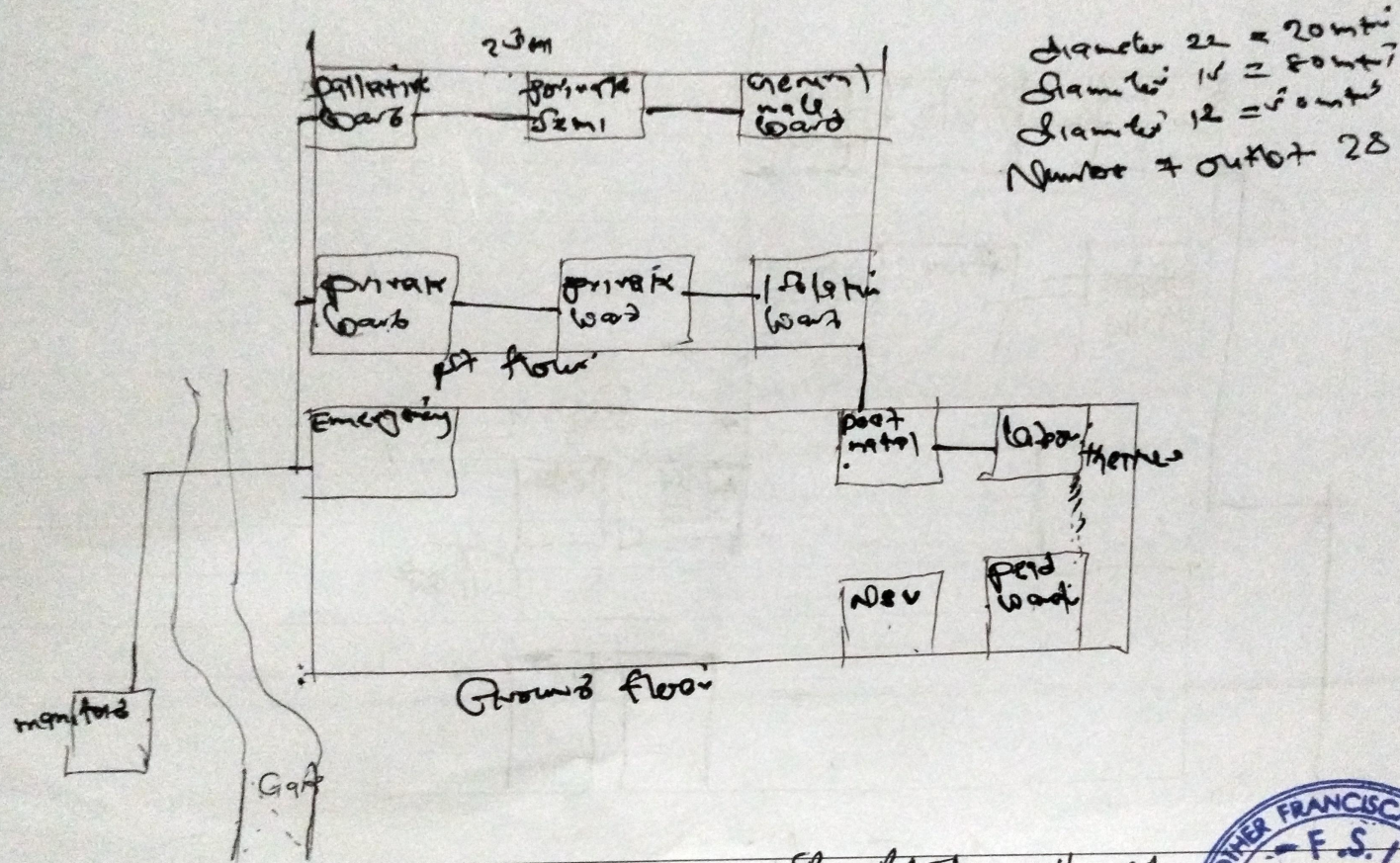

Proposed Drawing Approved By: (Name/ Designation / Date) SR RAEL CHUMBA

Signature & Stamp *Rael Chumba*

